

AMB200 Temperature Sensing Device for Bus Connectors

Installation and Operation Instruction V1.0

Declaration

All rights reserved. Without the written permission of the company, the contents of any paragraphs and chapters in this manual shall not be copied, copied or reproduced or disseminated in any form. Otherwise, all consequences shall be borne by the violator.

The company reserves all legal rights.

The company reserves the right to modify the specifications described in this manual without prior notice. Before ordering, please consult your local agent for new specifications.

Contents

1. Overview.....	1
2. Model and specifications.....	1
3. Technical parameters.....	1
4. Installation instructions	2
4.1 Overall dimensions.....	2
4.2 Probe regulation.....	2
5. Operation guide.....	3
5.1 Online 4-channel temperature sensing in real time.....	3
5.2 Humidity sensing of bus duct.....	3
5.3 Communication mode.....	3
5.4 Early warning and alarm functions.....	4
5.5 Display functions.....	4
5.5.1 LED lamps.....	4
5.5.2 Nixie tubes.....	4
5.6 Buttons.....	5
6. Communication instructions.....	5
6.1 General information.....	5
6.2 Protocol.....	5
6.2.1 Data frame format.....	6
6.2.2 Address field.....	6
6.2.3 Function field.....	6
6.2.4 Data field.....	6
6.2.5 Error check field.....	6
6.3 Error check methods	6
6.4 AMB200 communication parameter address list.....	7
6.5 Communication application.....	9
6.5.1 Data reading.....	10
6.5.2 Data writing.....	10
7. Diagnostics and troubleshooting of common faults.....	10
7.1 Operation failure of the power-on device.....	10
7.2 Failure of RS-485 communication.....	10
7.3 Failure of wireless communication.....	10

1. Overview

AMB200 Temperature Sensing Device for Bus Connectors is designed to monitor the temperature of insulated connectors in the bus duct online. It enables the real-time monitoring of bus temperature in the bus duct, hi-temperature early warning and alarm. Early warning and alarm values are configurable. The optional RS485 or wireless transmission works to transmit the acquired bus temperature, temperature change and other related data to the monitoring system in real time. The typical application is the online temperature monitoring system for insulated bus connector cluster in various fields.

2. Model and specifications

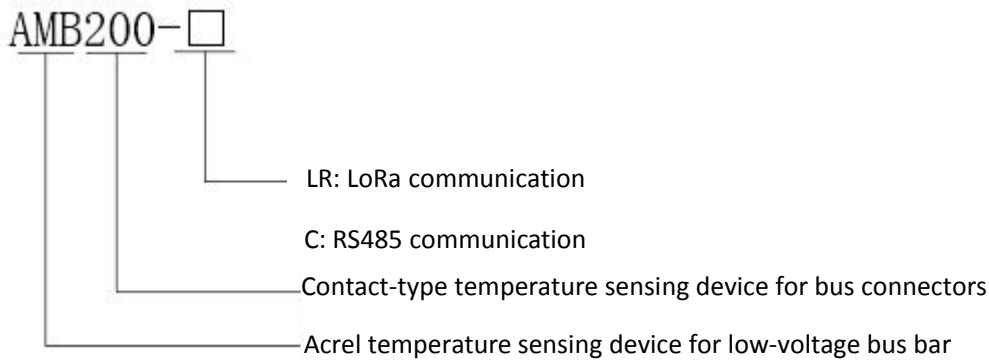

3. Technical parameters

Technical parameters		AMB200
Measurement	Function	4-channel temperature and humidity
	Range	Temperature: -20°C-200°C, relative humidity: 20%-90%
	Accuracy	Temperature: ±2°C, relative humidity: ±5%
Auxiliary power supply		Built-in probe (85-265VAC/DC)
Communication		LoRa, RS 485, infrared
Protection		LoRa: IP65 for the front panel RS485: IP30 for the front panel
Pollution level		2
Safety	Insulation	>100MΩ among probes A, B, C and N (after fuses are removed)
	Withstanding voltage	When a voltage of 2kV AC is applied among probes A, B, C and N and the communication port, the leakage shall be less than 2mA and no breakdown or flashover shall occur (after fuses are removed) in 1min.
Electromagnetic immunity	Electrostatic discharge immunity	Class 3
	Transient burst immunity	Class 4
	Surge immunity	Class 4
	Radiofrequency electromagnetic immunity	Class 3
Environment	Temperature of the device	Working temperature: -20°C-85°C Storage temperature: -40°C-85°C

Temperature of probes	Working temperature: -20°C-200°C Storage temperature: -40°C-85°C
Humidity	Relative humidity: ≤93%, no condensing
Altitude	≤2000m

4. Installation instructions

4.1 Overall dimensions

Unit: mm

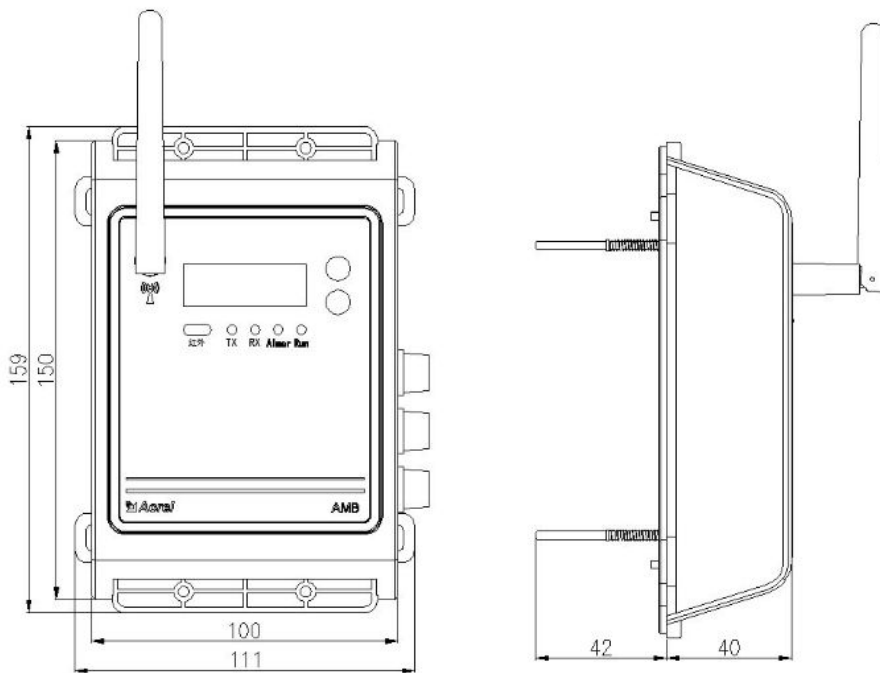
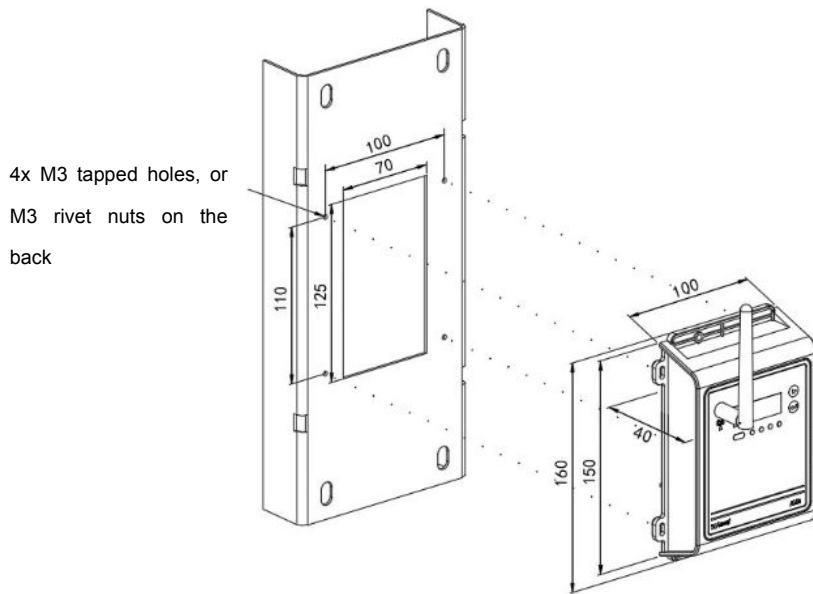

Fig.1 Built-in Contact Probe

4.2 Probe regulation

Built-in contact probes A, B, C and D are adjustable left and right for various phase spacing of bus bars. Specifically, they are compatible with bus bars with phases 10mm to 18 mm spaced. There are five divisions, A, B, C, D and E on each probe (as shown in Fig. 3). These divisions correspond to the spacing of 10mm, 12mm, 14mm, 16mm and 18mm. Select the division according to the bus bar for which the probe is installed.

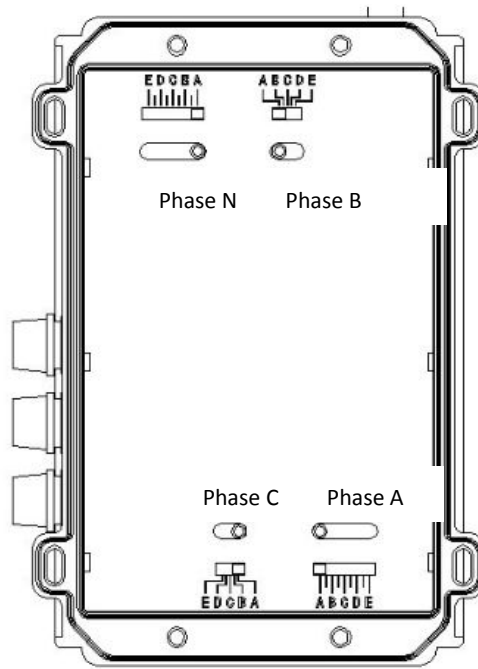

Fig. 2 Regulator

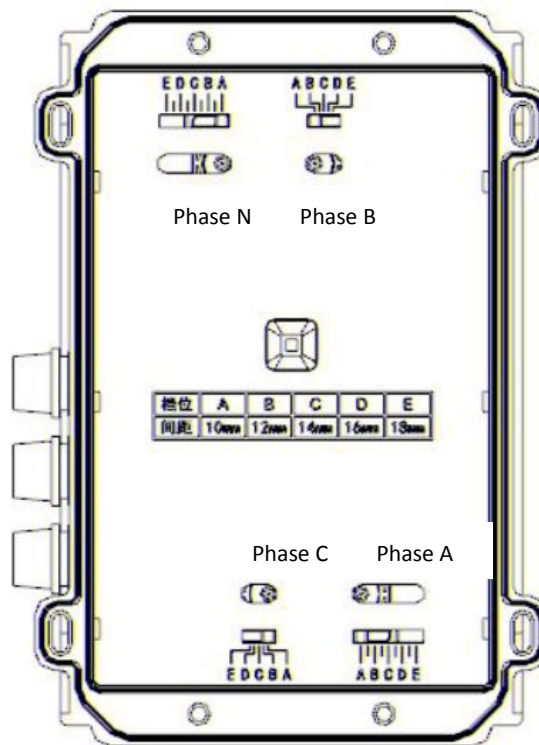

Fig. 3 Holes on the Back

5. Operation guide

5.1 Online 4-channel temperature sensing in real time

Four built-in probes monitor the real-time temperature of bus connectors A, B, C and N.

5.2 Humidity sensing of bus duct

Holes on the back of this device are used to monitor the humidity of bus duct.

5.3 Communication mode

Adopt RS485 or LoRa (optional) in one channel and infrared in the other. This device uploads the temperature measurements to the monitoring system via RS485, LoRa or infrared.

5.4 Early warning and alarm functions

When the measured parameters exceed the early warning or alarm setting, this device will send an alarm via buzzer and record the alarm time.

5.5 Display functions

There are four nixie tubes and four LED lamps. The specific meaning of these components is as follows:

5.5.1 LED lamps

Four LED lamps are named Run, Alarm, Rx and Tx.

Run: turn on and then off in 1s after this device starts

Alarm: keep on when the measured value reaches the alarm setting

Rx: start flashing when this device receives the data

Tx: start flashing when this device sends the data

5.5.2 Nixie tubes

Under normal circumstances, the following eight screens are displayed in cycle. When the measured value reaches the alarm setting (for example, phase-A temperature at 42°C while the alarm setting is 40°C), the 1st screen will be displayed as shown in Table 1.

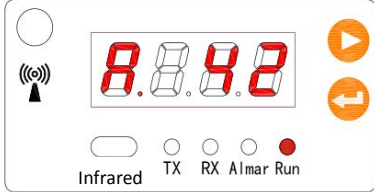
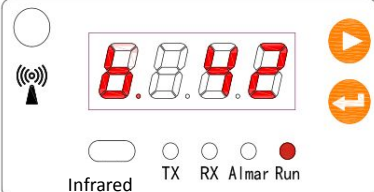
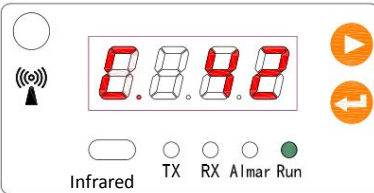
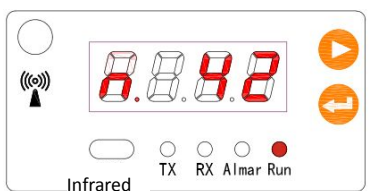
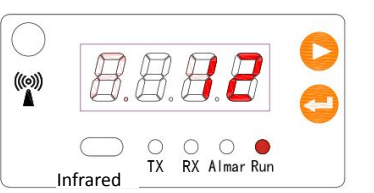
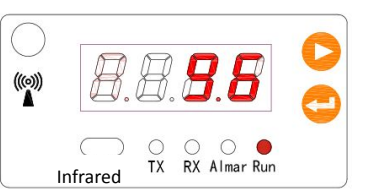

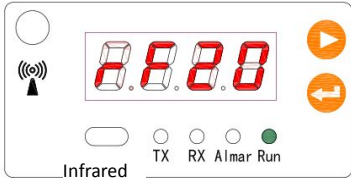
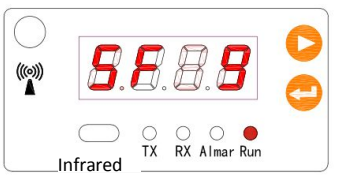

	Sketch	Description
1st screen		Phase-A temperature at 42°C
2nd screen		Phase-B temperature at 42°C
3rd screen		Phase-C temperature at 42°C
4th screen		Phase-N temperature at 42°C
5th screen		RS485 address (ADDR): 12
6th screen		RS485 baud rate: 9600

7th screen		LORA frequency (RF): 470+20=490MHZ
8th screen		LORA spreading factor (SF): 9

5.6 Buttons

 : paging or confirmation

 : parameter + or cancellation of parameter saving

After this device is powered, screens in Table 1 will be displayed in cycle. Press and hold  to check the information on baud rate (baud), communication address (Addr), LORA frequency (RF) and LORA spreading factor (SF) and show screen SAVE. Press  to check specific parameters on screens. If a parameter is adjusted, press  to confirm your action. If you press  on screen SAVE, parameter saving will be cancelled. After pressing buttons, screens will be displayed as below:

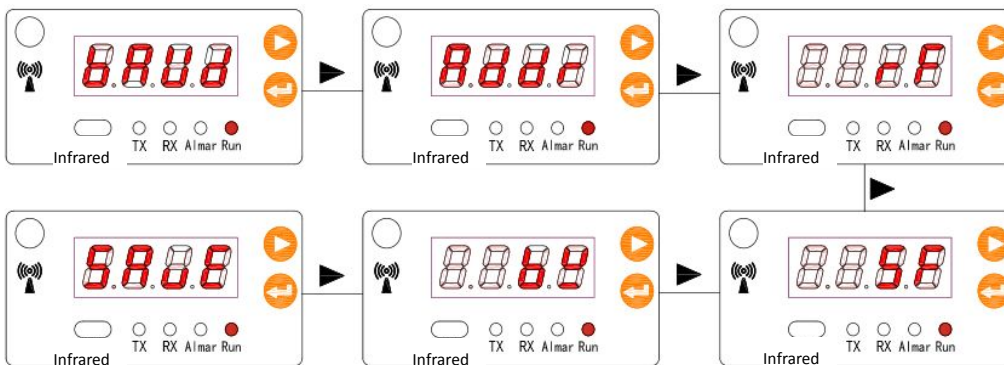

6. Communication instructions

6.1 General information

AMB200 employs Modbus-RTU. Default parameters are described in Table 2:

Communication mode	Baud rate	Data bit	Check digit	Stop bit
Infrared	1200	8	E	1
485	9600	8	N	1
	Frequency, MHZ	Spreading factor	Band width	
LORA	482	8	9	

Table 2 Default Protocol Parameters

Note: N= no parity; e= even parity

Error check= CRC 16 (cyclic redundancy check)

6.2 Protocol

When reaching the addressed terminal unit, a data frame will enter it through a simple “port”. In this unit, the

envelope of the data frame (data header) is removed and the contained data is read. If there is no error, the request of data will be executed. Then the terminal unit will generate and input its data into the removed envelope and return the data frame to the sender. The response data returned contains: the address of terminal slave unit (Address), the function executed (Function), requested data generated from the function (Data) and a CRC check digit (Check). If there is any error, no response will be made or an error indication frame will be returned.

6.2.1 Data frame format

Address	Function	Data	Check
8-Bits	8-Bits	NX8-Bits	16-Bits

Table 3 Data Frame Format

6.2.2 Address field

A data frame starts from address field that consists of one byte (8-Bits, 8 binary codes). It is from 0 to 255 in decimal, in which 1 to 247 is used in our system and the rest is reserved. It indicates the address of a terminal unit that user designates to receive the data from the master unit. The address of each terminal unit of one bus must be exclusive. Except for the addressed terminal unit, other terminal units will not respond to an inquiry containing its address. When the terminal unit returns a response, the master unit will identify it according to the slave address contained in the response signal.

6.2.3 Function field

The function field indicates the function to be executed by the addressed terminal unit. The following list gives all function codes used by AMB series as well as the meaning and role.

Code (hexadecimal system)	Meaning	Behavior
03H	Read the holding register	Acquire the current binary value from one or several holding registers
10H	Preset multiple registers	Load a specific binary value into a series of holding registers

Table 74 Function Field

6.2.4 Data field

The data field contains the data that is required for a terminal unit to execute a specific function or acquired by a terminal unit in response to inquiries. The data may be values, parameter addresses or set values.

When the function field requests a terminal unit to read a register, for example, the data field shall indicate the first register and the size of data to read. Content of the embedded address and the data depends on the type and the slave unit.

6.2.5 Error check field

The check field employs CRC16 check and enables both master unit and terminal unit to check transmission errors. When being transmitted from one unit to another unit, a set of data may change partly because of electrical noise or other interferences. In such case, the error check ensures that neither master unit nor slave unit responds to such change, improving the system safety, reliability and efficiency.

6.3 Error check methods

The error check (CRC) field occupies two bytes and contains one 16-bits binary value. A CRC value is calculated in the transmitting unit and loaded to the data frame. After receiving the data, the receiving unit will make a calculation again and compare the calculated CRC value with the received one. If they are different, it indicates that there is an error.

For CRC calculation, preset 1 at all bits of a 16-bits register and then operate 8 bits of each byte in the data frame and the current value of the register continuously. It is only 8 data bits of each byte to participate in CRC generation. The start bit, stop bit or parity bit, if any used, will not have an influence on CRC. After such 8 bits and the register

content are operated by XOR for CRC generation, move the result to the lower bits and fill the higher bits with 0. Shift out and detect the lowest bit (LSB). If the lowest bit is 1, operate the register and a preset fixed value (0A001H) by XOR. If it is 0, no processing is required. Repeat these steps until all of eight bits shift.

CRC generation process:

1. Preset a 16-bits register to be 0FFFFH (1 at all bits) and name it CRC register.
2. Operate 8 bits of the first byte in the data frame and lower bits of CRC register by XOR and return the result to CRC register.
3. Move CRC register right by one bit. Fill the highest bit with 0. Shift out and detect the lowest bit.
4. If the lowest bit is 0, repeat step 3 (further movement). If the lowest bit is 1, operate the register and a preset fixed value (0A001H) by XOR.
5. Repeat steps 3 and 4 until eight movements complete. By then, all of 8 bits are processed.
6. Repeat steps 2 to 5 for the next 8 bits until all bytes are processed.
7. The final CRC register value is CRC value.

In addition, CRC value can be calculated by looking up table. This method is mainly characterized by quick calculation. However, a big memory is required. Please consult relevant data for more details.

6.4 AMB200 communication parameter address list

Address	Data content	Data type	Data length (byte)	Read/ write	Remark
0x0000	SN	uint16_t	2	R/W	Serial number
0x0001			2		
0x0002			2		
0x0003			2		
0x0004			2		
0x0005			2		
0x0006			2		
0x0007-0x000F	(reserved)	uint16_t	18	R/W	(reserved)
0x0010	Address	uint16_t	2	R/W	0-247
0x0011	Baud rate	uint16_t	2	R/W	0-1200 1-2400 2-4800 3-9600 4-19200 5-38400
0x0012	Check mode	uint16_t	2	R/W	0-None 1-Odd 2-Even
0x0013~0x001F	(reserved)	uint16_t	26	R/W	(reserved)
0x0020	LORA frequency (FB)	uint16_t	2	R/W	Transmitting frequency=FB+470 MHZ
0x0021	LORA spreading factor(SF)	uint16_t	2	R/W	
0x0022	LORA band width (BW)	uint16_t	2	R/W	
0x0023~0x002F	(reserved)	uint16_t	26	R/W	(reserved)
0x0030	Early temperature warning setting	int16_t	2	R/W	°C
0x0031	Temperature alarm setting	int16_t	2	R/W	°C
0x0032	Alarm delay time	uint16_t	2	R/W	Second
0x0033	Channel-A temperature	int16_t	2	R	0.1°C

0x0034	Channel-N temperature	int16_t	2	R	0.1°C
0x0035	Channel-C temperature	int16_t	2	R	0.1°C
0x0036	Channel-B temperature	int16_t	2	R	0.1°C
0x0037	(reserved)	int16_t	2	R	(reserved)
0x0038	(reserved)	int16_t	2	R	(reserved)
0x0039	(reserved)	int16_t	2	R	(reserved)
0x003A	(reserved)	int16_t	2	R	(reserved)
0x003B	Temperature alarm flag bit	uint16_t	2	R	bit0: early temperature warning of channel-A bit1: early temperature warning of channel-N bit2: early temperature warning of channel-C bit3: early temperature warning of channel-B bit4: (reserved) bit5: (reserved) bit6: (reserved) bit7: (reserved) bit 8: channel-A temperature alarm bit9: channel-N temperature alarm bit10: channel-C temperature alarm bit11: channel-B temperature alarm bit12: (reserved) bit13: (reserved) bit14: (reserved) bit15: (reserved)
0x003C	Total early warning time of 1 st channel	uint16_t	2	R	second
0x003D	Total early warning time of 2 nd channel	uint16_t	2	R	second
0x003E	Total early warning time of 3 rd channel	uint16_t	2	R	second
0x003F	Total early warning time of 4 th channel	uint16_t	2	R	second

0x0040	Total early warning time of 5 th channel	uint16_t	2	R	second
0x0041	Total early warning time of 6 th channel	uint16_t	2	R	second
0x0042	Total early warning time of 7 th channel	uint16_t	2	R	second
0x0043	Total early warning time of 8 th channel	uint16_t	2	R	second
0x0044	Total alarm time of 1 st channel	uint16_t	2	R	second
0x0045	Total alarm time of 2 nd channel	uint16_t	2	R	second
0x0046	Total alarm time of 3 rd channel	uint16_t	2	R	second
0x0047	Total alarm time of 4 th channel	uint16_t	2	R	second
0x0048	Total alarm time of 5 th channel	uint16_t	2	R	second
0x0049	Total alarm time of 6 th channel	uint16_t	2	R	second
0x004A	Total alarm time of 7 th channel	uint16_t	2	R	second
0x004B	Total alarm time of 8 th channel	uint16_t	2	R	second
0x004C	Humidity	float	4	R	W
0x004D					
0x004E~0x004F	(reserved)	uint16_t	8	R	(reserved)
0x0050	Control	uint16_t	2	W	bit0: buzzer cleared bit1: total alarm time and total early warning time cleared
0x0051	Model	uint16_t	2	R/W	1: AMB200 2: reserved

6.5 Communication application

All examples in this section are basically in the following form (hexadecimal data).

Addr	Fun	Data start		Data # of		CRC16	
		reg Hi	reg Lo	reg Hi	reg Lo	Lo	Hi
01H	03H	00H	00H	00H	06H	CRC_L	CRC_H
Address	Function code	Data start address		Number of data read		Cyclic redundancy check digit	

Table 5 Application of Communication Address

6.5.1 Data reading

Example 1. Read the channel-A temperature

Inquiry data frame	01 03 00 30 00 02 C4 04
Return data frame	01 03 04 03 b2 00 00 5a 50

Table 6 Data Reading

Keys:

01: slave address

03: function code

04: hexadecimal system. It is 4 in decimal. Indicate that 4-bytes data is followed.

5a50: cyclic redundancy check digit

For the data processing method, please refer to 6.4 Communication Parameter Address List

Data processed as follows: 03b2 (hexadecimal)=946 (decimal)

6.5.2 Data writing

Example 2: remote clearing of buzzer (control byte: 0050H)

Writing data frame	01 10 00 50 00 01 02 00 01 6B C0
Return data frame	01 10 00 50 00 01 01 D8

Table 7 Data Writing

Note:

To clear the buzzer remotely, write 1 in the control bit. To maintain the buzzer, write 0.

7. Diagnostics and troubleshooting of common faults

7.1 Operation failure of the power-on device

* Power on the device again. Remove the fuse base and re-assemble the device.

7.2 Failure of RS-485 communication

* Check if the communication baud rate, ID and communication protocol setting of master unit are consistent with the device.

* Check if the data bits, stop bit and check digit of the device are set as the master unit.

* Check if the RS232/RS485 converter works normally.

* Check if the entire communication network is normal (e.g. short circuited, circuit broken, earthing and single-end earthing of shielded wire).

* Turn off the device and the master unit and then turn them on.

* It is recommended for a long communication line to connect a compatible resistor (approx. 100 to 200 ohm) at the line terminal in parallel.

7.3 Failure of wireless communication

* Check if the communication band of the wireless master unit is consistent with the device.

* Check if there is any local co-channel interference.

* Check if the wireless communication signal of the master unit covers the device.

* Turn off the device and the master unit and then turn them on.

Headquarters: Acrel Co.,LTD.

Address: No.253 Yulv Road Jiading District,Shanghai,China

TEL.: 0086-21-69158338 0086-21-69156052 0086-21-59156392 0086-21-69156971

Fax: 0086-21-69158303

Web-site: www.acrel-electric.com

E-mail: ACREL008@vip.163.com

Postcode: 201801

Manufacturer: Jiangsu Acrel Electrical Manufacturing Co.,LTD.

Address: No.5 Dongmeng Road,Dongmeng industrial Park,Nanzha Street,Jiangyin City,Jiangsu Province,China

TEL./Fax: 0086-510-86179970

Web-site: www.jsacrel.com

Postcode: 214405

E-mail: JY-ACREL001@vip.163.com