

# AM2SE Protection Relay

User Manual V1.4

# **DECLARATION**

All rights reserved. No part of this publication may be reproduced, stored in a retrieval system, or transmitted in any form by any means, electronic, mechanical photocopying, recording, or otherwise without prior permission of our company. The violator will bear the dependent legal responsibility.

We reserve all the rights.

We reserve all the rights to revise product specification without notice. Please consult local agent to get the latest information of our products specification.

# Catalogue

1	Introduction.....	1
1.1	Product Overview.....	1
1.2	Selection guide by application.....	2
1.3	Relay Selection Table.....	3
2	Technical Characteristics.....	4
2.1	Rated Characteristics.....	4
2.2	Protection Characteristics.....	5
2.3	Environmental Characteristics.....	5
2.4	Product Safety.....	5
2.5	EMC [Electromagnetic Compatibility].....	5
3	Use.....	7
3.1	Front Panel Introduction.....	7
3.2	Push buttons.....	7
3.3	Menu Description.....	7
3.3.1	Navigation.....	8
3.3.2	Configuration.....	9
3.3.3	Parameter.....	10
3.3.4	Digital Input Configuration.....	11
3.3.5	Debug.....	12
3.3.6	Record.....	12
3.3.7	Communication.....	13
3.3.8	Control.....	13
3.3.9	Time.....	13
3.3.10	Information.....	14
4	Dimension and Installation.....	15
4.1	Dimensions and Cut-out Dimension.....	15
4.2	Installation procedure.....	17
5	Wiring.....	18
5.1	AM2SE rear panel.....	18
5.2	Typical application.....	19
6	Product Maintenance.....	22
	Appendix A Setting value.....	23
	Appendix B Remote address table.....	40
	Appendix C Relay Event.....	52
	Appendix D AM5-FT Anti-pumping.....	89

# 1 Introduction

## 1.1 Product Overview

The AM2SE protection relay has the modular design and it can be optimized to feeder protection applications in medium voltage distribution systems. The relay is widely used in substations, hospitals, schools, commercial plazas, large buildings and so on.

### **Main characteristic**

#### ➤ **Protection functions**

The AM2SE relay has a modular design and it can be optimized to the line, transformer, PT protection applications in medium voltage distribution systems.

#### ➤ **Robust Hardware and Software**

Industrial-grade components with professional EMC design.

High-performance processor with large capacity RAM and Flash for advanced data processing.

#### ➤ **User-machine interface(UMI)**

Clear LCD display for alarms and events

Programmable functions buttons and LEDs

#### ➤ **Rich measuring inputs**

4 phase currents (AC)

3 phase voltages (AC)

8 digital inputs (AC/DC), support user-defined

5 digital outputs

#### ➤ **Communication**

1 RS485 communication port

Powerful CPU supporting Modbus-RTU, IEC 60870-5-103

#### ➤ **Flexible and Convenient Wiring**

Supports phase voltage, line voltage, zero-sequence voltage, or unbalanced voltage connections.

The protection current can be connected to three-phase current, and the other AC current can be connected to zero sequence current or unbalanced current.

## 1.2 Selection guide by application

Analogue inputs	AM2SE	
	V	H
Input Current	4	
Input Voltage	3	
Protection Functions	V	H
Overcurrent (3 stages,IDMT) [ANSI 50/51]	√	
Earth fault (3 stages,IDMT) [ANSI 50N/51N]	√	
Negative sequence overcurrent (2 stages,IDMT) [ANSI 46]	√	
Auto-reclose [ANSI 79]	√	
Overload (trip/alarm) [ANSI 49F]	√	
Under frequency [ANSI 81U]	√	
Post-accelerated overcurrent	√	
I0 Post-accelerated overcurrent	√	
Overvoltage(trip) [ANSI 59]	√	
Undervoltage (trip) [ANSI 27]	√	
Self-produced over zero-voltage (trip) [ANSI 59N]	√	
Residual overvoltage (trip) [ANSI 59N]	√	
FC block [ANSI 86]	√	
Trip and close circuit supervision (alarm) [ANSI 74]	√	
Non-electricity (trip/alarm)	√	
Undervoltage (alarm) [ANSI 27]	√	
Overvoltage (alarm) [ANSI 59]	√	
Residual overvoltage (alarm) [ANSI 59N]	√	
PT supervision (alarm)	√	
Self-produced over zero-voltage (alarm) [ANSI 59N]	√	
Overhaul-lockout [ANSI 86]	√	
2nd harmonic restraint	√	
Rear port	V	H
RS485(1 port)	√	
Protocols	V	H
Modbus serial	√	
IEC 60870-5-103	√	
Measurement	V	H
Electric parameter	U,I,P,Q,PF,Fr,Ep,Eq,Es	
Logs and Records	V	H
Fault recorder	√	
Sequence of event record	√	
Others	V	H
Anti-pumping circuit	■	
Remote control	√	

Note: √ means with this function, ■ means optional function.

1.3 Relay Selection Table

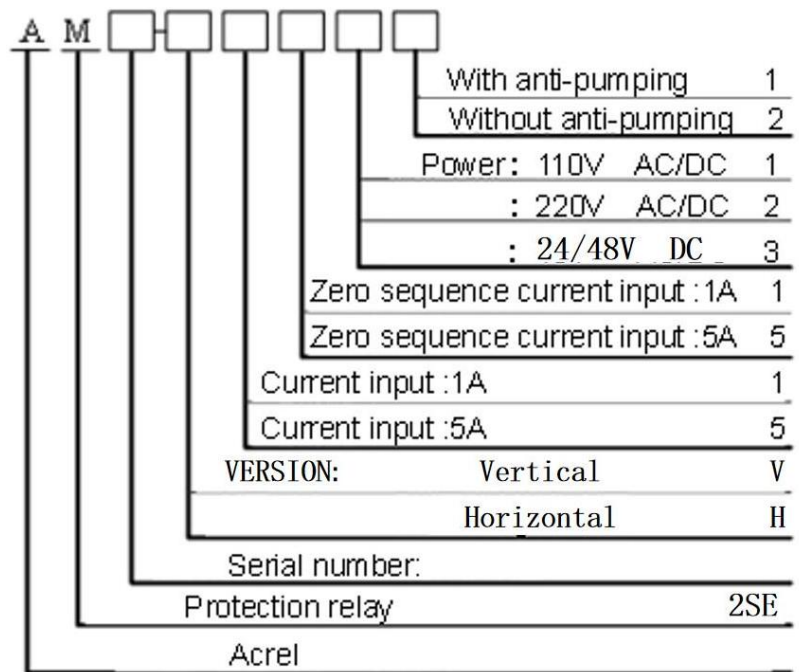

## 2 Technical Characteristics

### 2.1 Rated Characteristics

Version	AM2SE
Characteristics	
<b>Power Supply</b>	
Rated voltage	AC/DC 110V or AC/DC 220V or DC48V or DC24V
Range	Rated voltage × (1±20%)
Burden	≤10W ( DC )
<b>PT Inputs</b>	
Rated value	AC 100V or $100/\sqrt{3}$ V
PT rated secondary range	1V~120V
Accuracy	0.5S
Burden	≤0.5VA (each phase)
Voltage withstand	Continuous: 1.2 Un 10s: 2 Un
<b>Phase CT Inputs (Protection Current)</b>	
CT rated secondary range	AC 5A or 1A
Dynamic	0.04 ~ 15 × CT rated current
Accuracy	0.5S
Burden	≤0.5VA (each phase)
Thermal withstand	Continuous: 2 In 1s: 40 In
<b>Frequency</b>	
Rated frequency	50Hz or 60Hz
Frequency range	45 ~ 65Hz
Accuracy	±0.1Hz
<b>Digital Inputs</b>	
Operating nominal voltage	AC/DC 110V or AC/DC 220V or DC48V or DC24V
Voltage threshold	70% of nominal voltage
Reset threshold	55% of nominal voltage
Burden	≤ 1W (each phase) (DC220V)
<b>Digital Outputs</b>	
Make and carry	≥ 10000 operations

Making capacity	$\geq 1000\text{W}$ , L / R = 40ms
Continuous current	$\geq 5\text{A}$
Short duration carry current	$\geq 30\text{A}$ for 200ms
Breaking capacity	$\geq 30\text{W}$ , L/R = 40ms

## 2.2 Protection Characteristics

Characteristics	Accuracy	Resolution	Disengaging ratio
Voltage	$\pm 3\%$	0.001V	0.95 and 1.05
Current	$\pm 3\%$	0.001A	0.95 and 1.05
Frequency	$\pm 0.02\text{Hz}$	0.001Hz	-
Inverse Time Element Operation delay t>(IDMT)	40ms or $\pm 5\%$ setting value	0.001s	-
Time Element Operation delay t>(DT)	$\leq 40\text{ms}$ [delay time within 2 seconds] $\leq 40\text{ms} \pm 1\%$ setting value [delay time larger than 2 seconds]	0.001s	-

## 2.3 Environmental Characteristics

Characteristics	Description/Value
Operating Temperature	$-10^{\circ}\text{C} \sim +55^{\circ}\text{C}$
Humidity	5% ~ 95% (No condensation and freeze inside)
Altitude	$\leq 2500\text{m}$
Enclosure	IP20 (local panel)

## 2.4 Product Safety

Characteristics	Description/Value
Insulation Resistance	$> 100\text{M}\Omega$ , 500Vdc
High voltages withstand	2kV rms AC, 1 min:between all case terminals connected together, and the case earth/ground; 2 kV rms AC, 1 min:between all terminals of independent circuits
Impulse Voltage	$\pm 5\text{kV}$ (1.2/50 $\mu\text{s}$ , 0.5J)

## 2.5 EMC [Electromagnetic Compatibility]

Characteristics	Standard	Level/Class
Radiated emission	IEC-60255-26:2023—5.1	A
Conducted emission	IEC-60255-26:2023—5.2	A



Radiated radio frequency fields	IEC-60255-26:2023	A
Electrostatic discharge	IEC-60255-26:2023—6.1	B
Conducted radio frequency disturbance	IEC-60255-26:2023—6.2-6.5	A
Fast transient bursts	IEC-60255-26:2023—6.2-6.5	B
Slow damped oscillatory waves	IEC-60255-26:2023—6.2-6.4	B
Surges	IEC-60255-26:2023—6.2-6.4	B
Voltage dips and short interruptions test (AC or DC)	IEC-60255-26:2023—6.2	A/C <sup>1</sup>
Magnetic field at power frequency	IEC-60255-26:2023—6.1	B

---

<sup>1</sup> AC and DC voltage dips meet the criteria A/C of the IEC60255-26:2023—6.2. AC and DC voltage interruptions meet the criteria C of the IEC60255-26:2023—6.2. Ripple on DC input power port immunity meet the criteria A of the IEC60255-26:2023—6.2. DC auxiliary power supply ports gradually shutdown/start-up meet the criteria C of the IEC60255-26:2023—6.2.

### 3 Use

#### 3.1 Front Panel Introduction

The AM2SE relay is equipped with a user friendly local panel which is shown in Figure 3.1

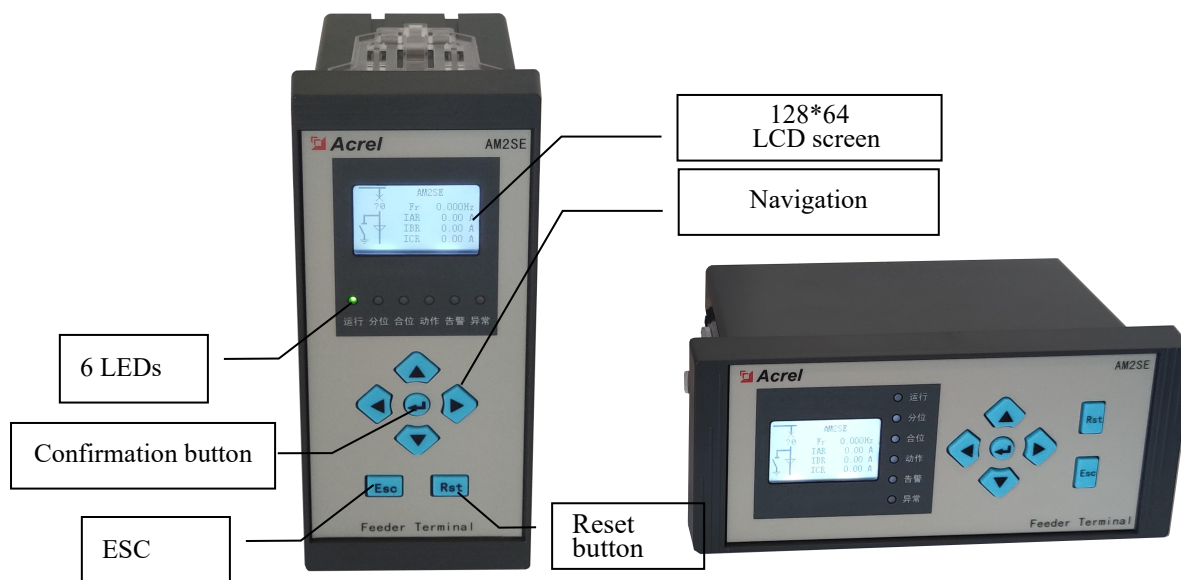











Fig.3.1 AM2SE Vertical & Horizontal surface

#### 3.2 Push buttons

Table 3.1 AM2SE Push buttons

Symbol	Function	Symbol	Function
	Reset button to release latches and reset LED status.		Move up the options or increase numbers
	Enter push-button for activating or confirming a function.		Move down the options or decrease numbers
	Esc button to return to the previous view.		Move left through options or flip pages forward
			Move right through options or flip pages backward

#### 3.3 Menu Description

The relay is powered on to enter the main screen(Mimic screen), and can take turns display Measurement, Remote Signal by pushing the  or  button.

**Figure 3.2 (1):**

The operation interface without a single-line diagram. This can be modified in the configuration menu under the "Main Interface Single-Line Diagram" option.

**Figure 3.2 (2):**

The operation interface with a single-line diagram. The single-line diagram displays the on/off status of the circuit breaker. Users can configure the "CB On/Off Position Acquisition" parameter in the settings :

**1) If set to "Dual-Point (CB On/Off)":**

When neither the CB On nor Off position input has a signal, it is displayed as "  $\times\phi$  ".

When the CB On position input has a signal, it is displayed as "  $\uparrow$  ".

When the CB Off position input has a signal, it is displayed as "  $\downarrow$  ".

**2) If set to "Single-Point (CB On Position)":**

When the CB On position input has no signal, it is displayed as "  $\times$  ".

When the CB On position input has a signal, it is displayed as "  $\uparrow$  ".

**3) If set to "Single-Point (CB Off Position)":**

When the CB Off position input has no signal, it is displayed as "  $\downarrow$  ".

When the CB Off position input has a signal, it is displayed as "  $\times$  ".

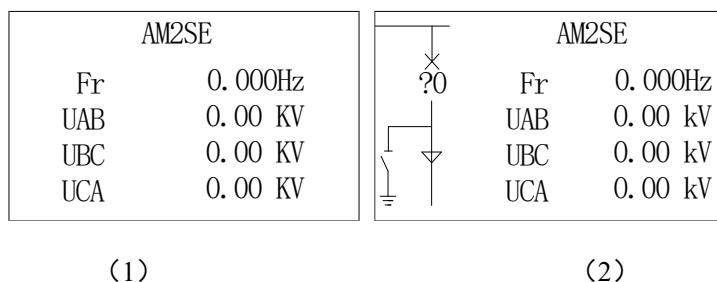

Fig. 3.2 Mimic screen

Name	Value	Unit
Ia	0.000	A
Ib	0.000	A
Ic	0.000	A
IO	0.000	A

Fig. 3.3 Measurement

Name	State
CCB On (YX_01)	OFF
CCB OFF (YX_02)	OFF

Fig. 3.4 Remote Signal

**3.3.1 Navigation**

The menu of relay is multi-level menu; Press the button to enter the main menu. There are 8 sub menus in the main menu, as shown as figure 3.5, which is composed of names and icons of sub menus. Press the button to enter either sub menu in the main menu, and press the button to return to the main menu.

button to return to the superior menu. Figure 3.6 shows the navigation diagram of the relay, which can be used to find relevant parameters quickly.

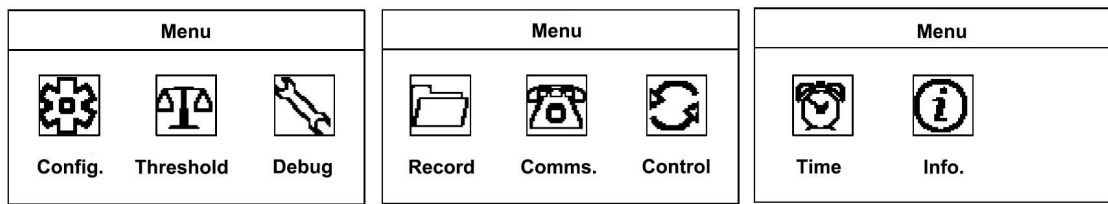

Fig. 3.5 Main Menu

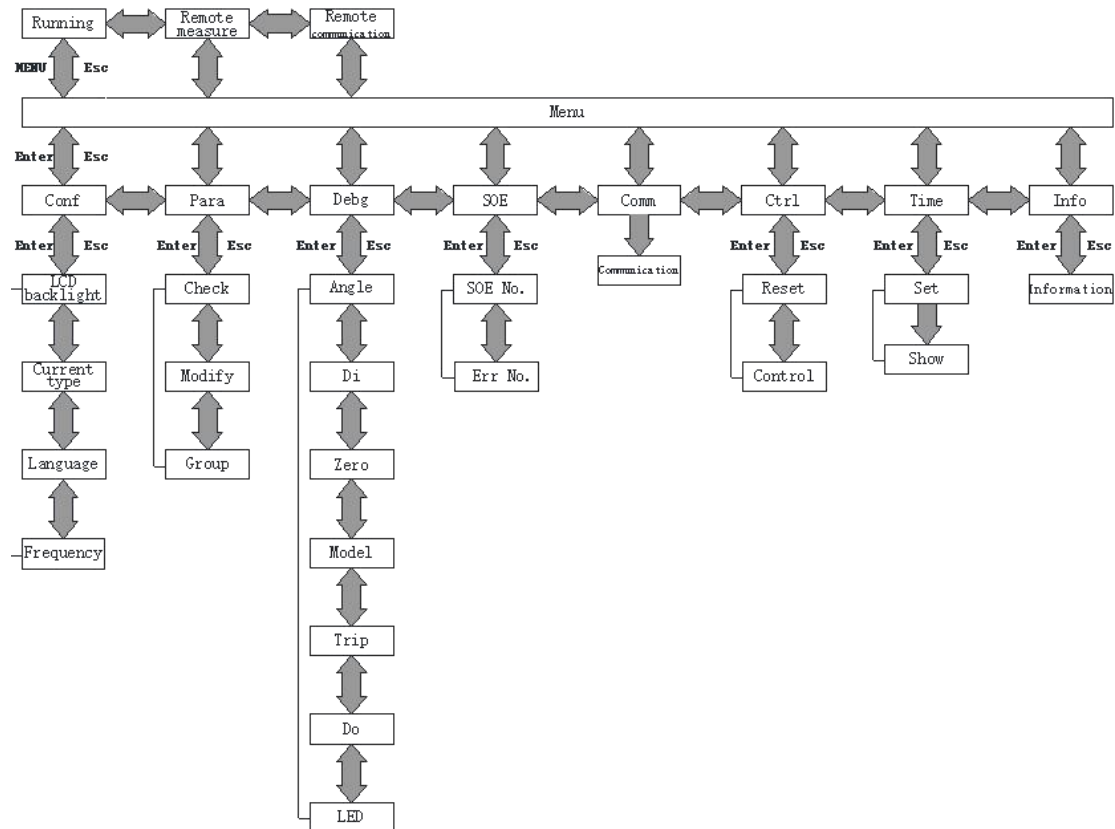





Fig. 3.6 Navigation diagram

### 3.3.2 Configuration

The "Conf" menu can set the LCD backlight time, as shown in Figure 3.7. After modification, press the  button to confirm the modification and press the  to return to main menu .The data saving interface will pop up, as shown in Figure 3.8 ;Press the  button to save the modification and return to the main menu, or press the  button to return to the main menu directly without saving the modification.

Setting	
LCD Backlight	060 s
CB Image	YES
Language(语言)	English
Rated Frequency	50HZ

Fig. 3.7 Backlight Time Setting





Setting	
<b>LCD Backlight 060 s</b>	
C	 Ente: Save Esc: Exit
L	
R	

Fig. 3.8 Configuration Save

### 3.3.3 Parameter

The "Para" menu includes 3 sub-menus: Value View, Value Modify and Switch Group, as shown in Figure 3.9.

#### A) Value View

The "Value View" menu includes two sub-menus: "Selected" and "Running". There are 4 groups of valid value in the "Selected", which are 00, 01, 02, and 03 areas. After selecting the corresponding area, as shown in Figure 3.10, press the  button to enter the "Value View" menu. All values can be viewed page by page by the  and  button, as shown as figure 3.11. The "Running" shows the current running area of the relay.

Para
<b>Check</b>
Modify
Group

Fig. 3.9 Parameter

PARA AREA
Selected: 00
Running: 00









Fig. 3.10 Selection area



Values[00]	(001)
<b>In_PT Select</b>	No
CT	10.000

Fig. 3.11 Value View

#### B) Modify

The "Modify" menu includes two sub menus: "Selected" and "Running". The initial password of this menu is "0008".

Set the group code in the "Selected", and enter the "Modify" by the  button. All the values are showed page by page, and select the values which need to be modified by the  ,  ,  and  buttons. The values can be selected by the  button, and be modified by the  and  button, as shown as figure 3.13. After the modification, press the  button to confirm the modification, and then set the next value as the same way.

After all modifications, press the  button to quit the "Modify". If value has been changed, the data saving interface will pop up, as shown as figure 3.8. Press the  button to

save the modification and return to the “Menu” .If press the  button, relay will return to the “Menu” directly without saving the modification.

The"Running" interface only shows the current running area of the relay, and no modification is made here.

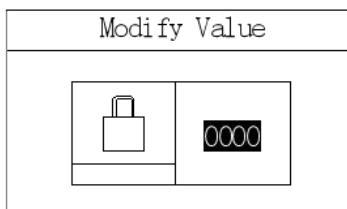

Fig. 3.12 Enter Password

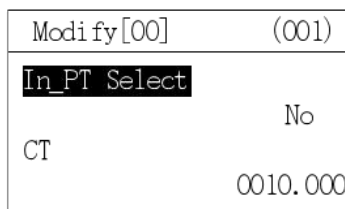

Fig. 3.13 Modify

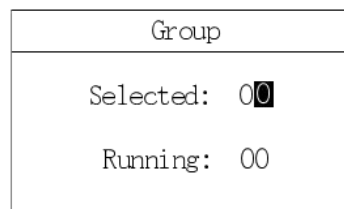

Fig. 3.14 Group

C) Group

The"Group"menu includes two sub menus:"Selected" and "Running". The initial password of this menu is"0008". There are four valid groups from 00 to 03 in the "Group". After setting, the modification can be confirmed by the the "Enter" button, and then return to the main menu by the "Esc"button.The running value area will display the current running value area of the relay, as shown in Figure 3.14.

3.3.4 Digital Input Configuration

Users can customize the digital input configuration of the relay according to the requirement. and set the corresponding digital input in the "Modify" according to the Accessories B Remote address table.

For purely digital input definitions, the actual remote signaling name needs to be set. For example, to change the third digital input to "Isolating Switch On", locate the corresponding code 1085 in Appendix B. Then, in the threshold menu, change the "Name03. C" to 00001085. After the modification, the updated input can be viewed in the remote signaling interface, as shown in Figure 3.15

Modify[00] (170)	Modify[00] (170)	Name	State
Name02. C 00000000	Name02. C 00000000	ISO. Switch On (YX_03)	Off
Name03. C 00000000	Name03. C 00001085	Discharge (YX_04)	Off

Fig. 3.15 Pure Digital Input Configuration

For the definition of functional digital inputs(such as CB On, CB Off ,Remote, ManualTrip, ManualClose, BlockReclosing, Discharge, Maintenance, and HighTemp.),it is necessary to set the name and configuration of the actual digital input. For example,users want to modify the fifth

digital input to "CB On". According to Appendix B, the code for "CB ON" can be found as 1079. Then the "Name05.C" should be modified to 00001079 in the "Modify". Next, the "CB On.C" in the "Modify" should be configured to 5. After the modification, it can be viewed in the digital inputs interface, as shown as figure 3.16.

Modify[00] (172)	Modify[00] (009)	Name	Stata
Name04. C 00000000	CB On. C 00000005	CB On (YX_05)	Off
Name05. C 00001079	CB Off. C 00000002	GroundSwitch (YX_06)	Off

Fig. 3.16 Functional Digital Input Configuration

### 3. 3. 5 Debug

The "Debg" menu is used to test before delivery. The function includes zero adjustment, amplitude adjustment, relay output test, LED test, LED color configuration, and relay output configuration.

**When use the "Debg" menu, please contact the manufacturer first!**

### 3. 3. 6 Record

The "REC" includes 2 types of record: Event Records and Error Records.

#### A) Event Record

The "SOE" menu shows the event sequence, total number of events, event code, event time, event name, action type (trip or alarm), and other information. It can also record the action values and time of the protection event, as shown in Figure 3.16. The relay can save more than 200 event records.

#### B) Error Record

The "Err" menu shows the error sequence, error counts, error time, error name, error code and so on, as shown in Figure 3.17. The relay can save more than 200 error records.

SOE No.	[002/026]	No	A11	SOE code	Parameters
Time	19-10-21 09:48:57.619				
Name	3I>>> [Set]				
SOE Par.	On Next Page				
SOE No.	[002/026]				
Ia	12.346A				
Ib	0.010A				
Ic	0.000A				
UAB	0.043V				
SOE No.	[002/026]				
UEC	0.022V				
UCA	0.021V				
U2	0.060V				
Ia_H2	0.008A				
SOE No.	[002/026]				
Ib_H2	0.010A				
Ic_H2	0.000A				

Fig. 3.17 Event Record

Err No.	[001/013]
19-11-14	09:44:05.000
Hardware Init	
ErrNo. : 0x000006	

Fig. 3.18 Error Record

### 3.3.7 Communication



As shown in Figure 3.19, the "Comm" menu can set the communication address of relay and baud rate. Communication parameters can be configured based on the options in Table 3.2. After setting the parameters, first press the  button, then press the  button to save the settings, and finally press the  button again to return to the main menu.

Table 3.2 Communication Parameter Settings

Item	Parameters
Relay Address	0~255
Baud Rate	4800、9600、19200、57600、115200
Data Bit	8、9
Stop Bit	1、1.5、2
Parity	None, Even, Odd
Protocol	MODBUS、IEC103

Comm	
Addr	00000
Protocol	IEC103
Baudrate	38400
DataBit	8

Fig. 3.19 Communication Configuration

### 3.3.8 Control

The "Control" menu is used to test before delivery. The function in this menu includes remote trip、remote close and signal reset.

**When use the "Ctrl" menu, please contact the manufacturer first!**

### 3.3.9 Time

The "Time" menu is used to modify the clock. As shown in Figure 3.20, press the "Enter" button after the time setting is completed, then press the "Esc" button to return to the main menu.



### 3.3.10 Information

The "Information" menu can display the basic information includes relay's name、 version、 check code、 hardware、 software、 logic、 logic version and so on, as shown in Figure 3.21.

Time
Press ENTER button to set system time 2019-11-15 13:21:46

Fig. 3.20 Time Setting

AM2SE	Information
Version:3.05	Hardware:
CRC:0x16f8	2019-12-13_11:49:40
Logic:V0020 1.00	Software:
2019-12-13_15:16:18	2019-12-13_11:49:44

Fig. 3.21 Information

## 4 Dimension and Installation

### 4.1 Dimensions and Cut-out Dimension

AM2SE-V (Vertical Ver.)

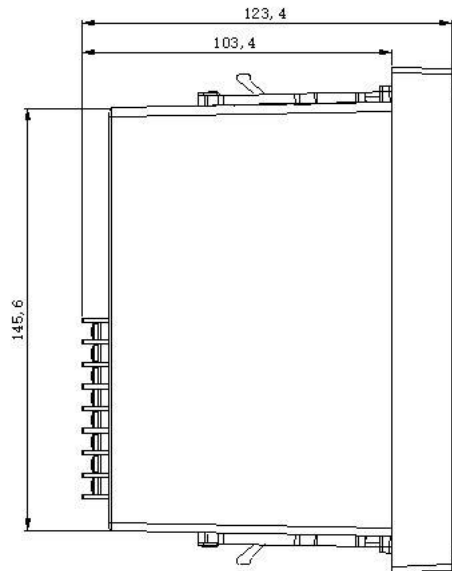

**Side View**

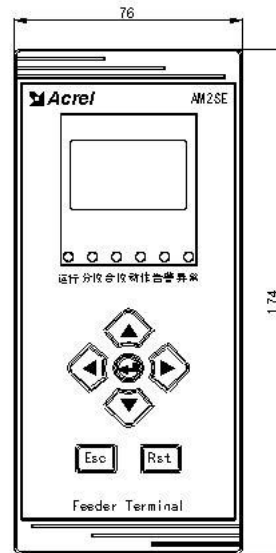

**Front View**

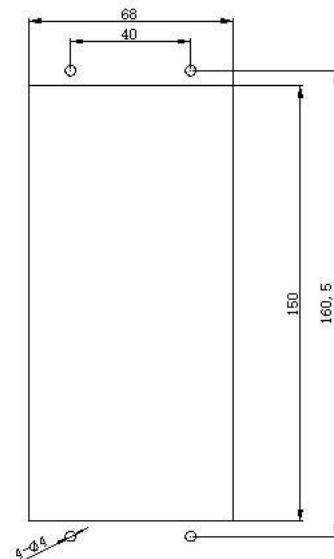

**Cut-out Dimension**

Fig. 4.1 AM2SE-V Dimensions and cut-out dimensions

**Note:**

1. Square cutout size is 150 x 68 mm.
2. Length unit is millimeter (mm).

AM2SE-H (Horizontal Ver.)

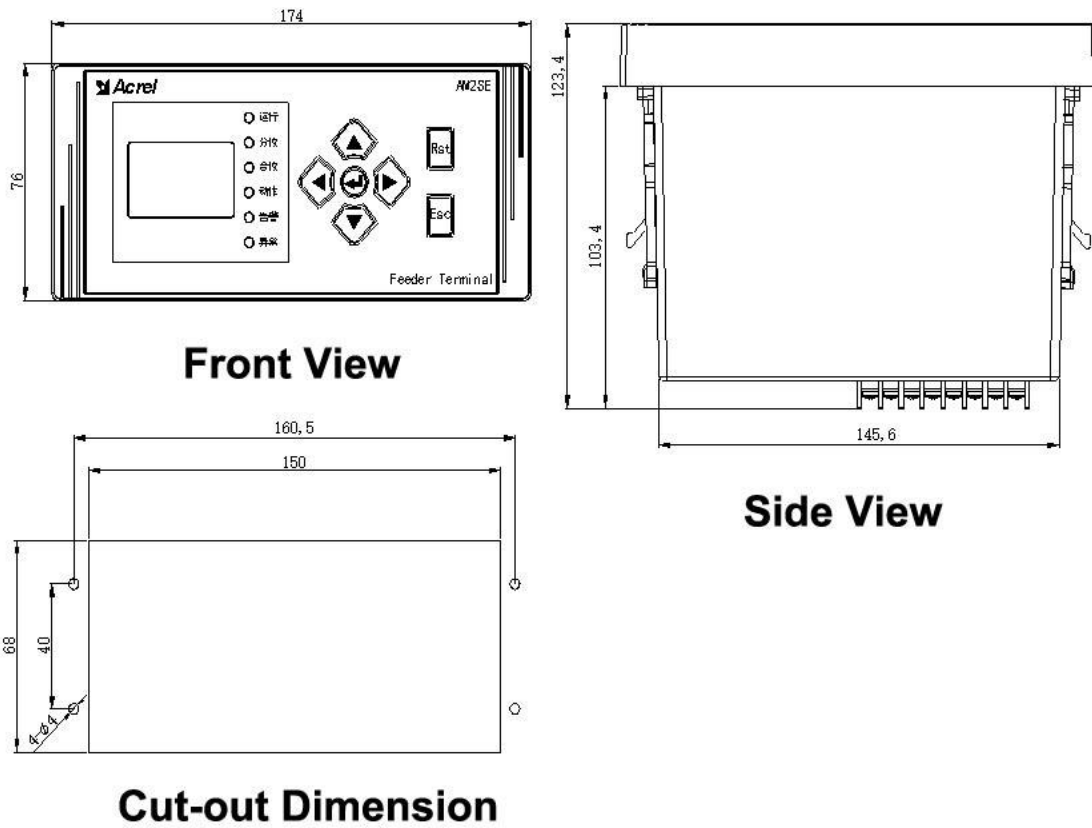

Fig. 4.2 AM2SE-H Dimensions and cut-out dimensions

**Note:**

1. Square cutout size is 68 x 150 mm.
2. Length unit is millimeter (mm).

## 4.2 Installation procedure

### 1. Prepare the cutout:

Create a cutout on the panel according to the specified cutout dimensions, as shown in Fig. 4.3.

### 2. Insert the relay:

Place the relay into the cutout until the relay panel rests flush against the cabinet panel.

### 3. Secure the relay:

Insert the fixing brackets of the relay to secure it firmly to the cabinet panel, as shown in Fig. 4.4.

Note:

1. For the AM2SE-V, the fixing brackets are located on the top and bottom of the relay. For the AM2SE-H, the fixing brackets are on the left and right sides of the relay.
2. The AM2SE package includes four screws. If required, these screws can be used to further secure the relay to the door panel after attaching the brackets. If not needed, the screws can be omitted.

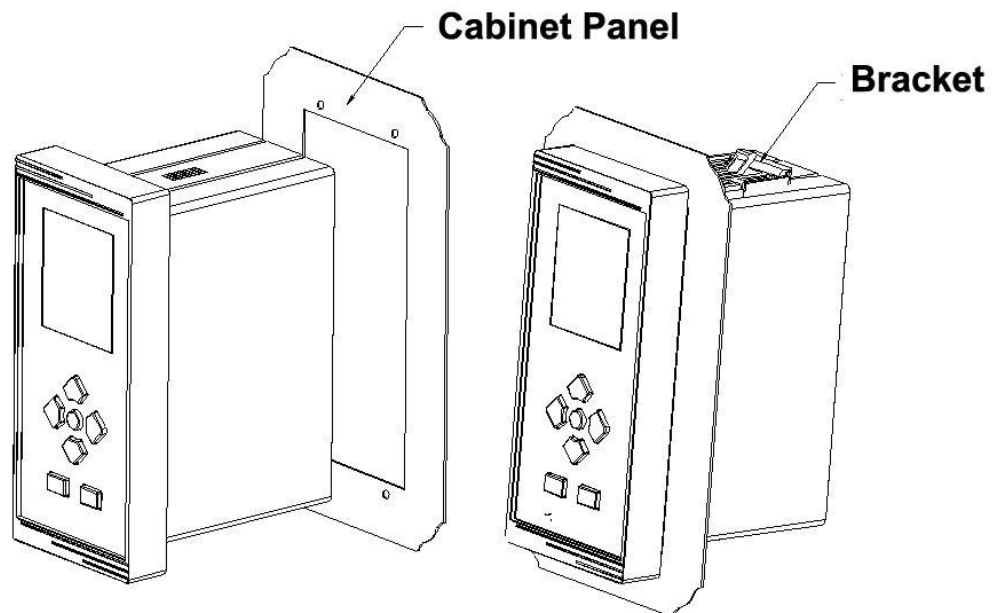

Fig. 4.3

Fig. 4.4

## 5 Wiring

### 5.1 AM2SE rear panel

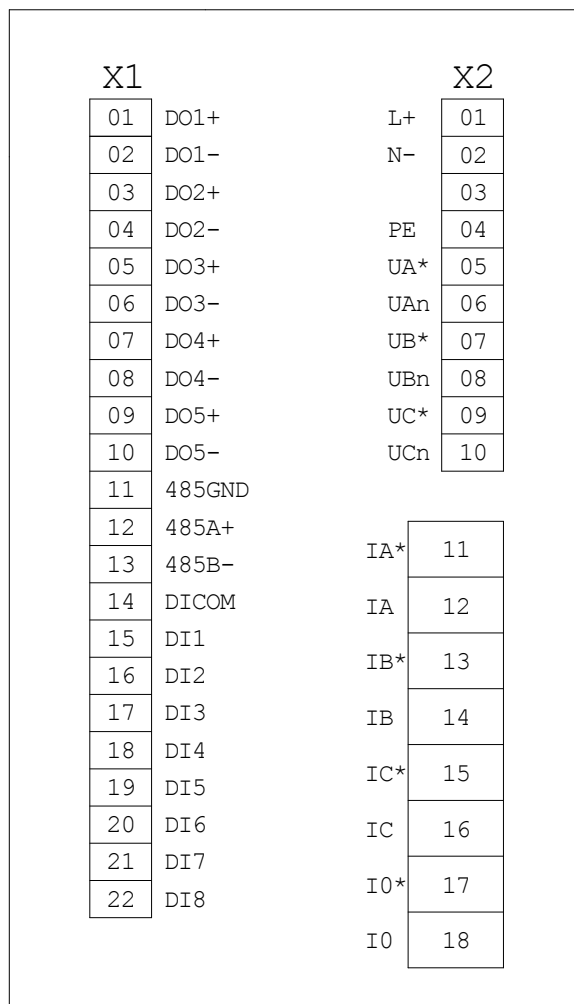

Fig. 5.1 AM2SE-V (AM2SE-H and AM2SE-V are the same)

X1	1-10	Digital outputs
X1	11-13	RS485
X1	15-22	Digital inputs
X2	1-2	Power supply
X2	3	Power ground
X2	5-10	Voltage
X2	11-18	Current

### 5.2 Typical application

The following describe typical application diagrams. 3CTs and residual current, 3PTs have been showed in the diagrams.

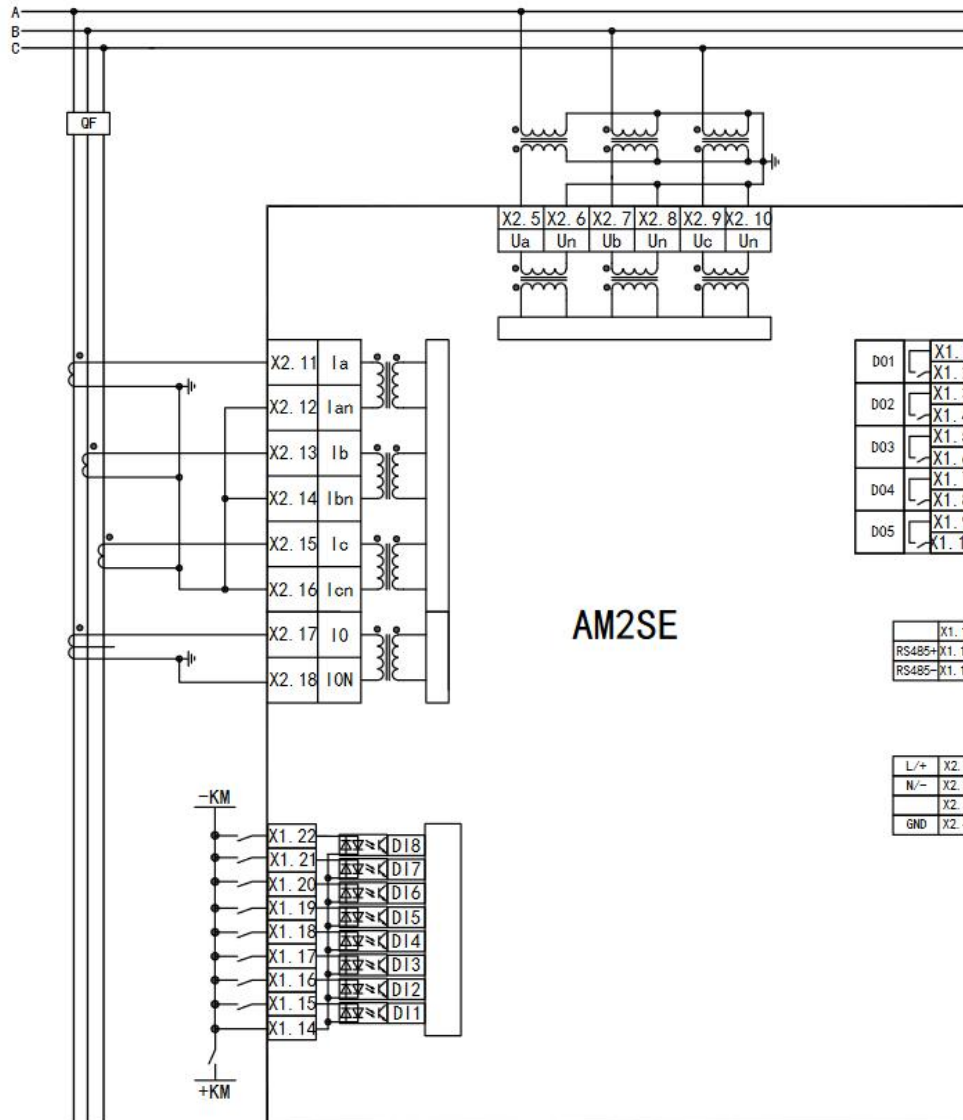

Fig. 5.2 Typical application diagram

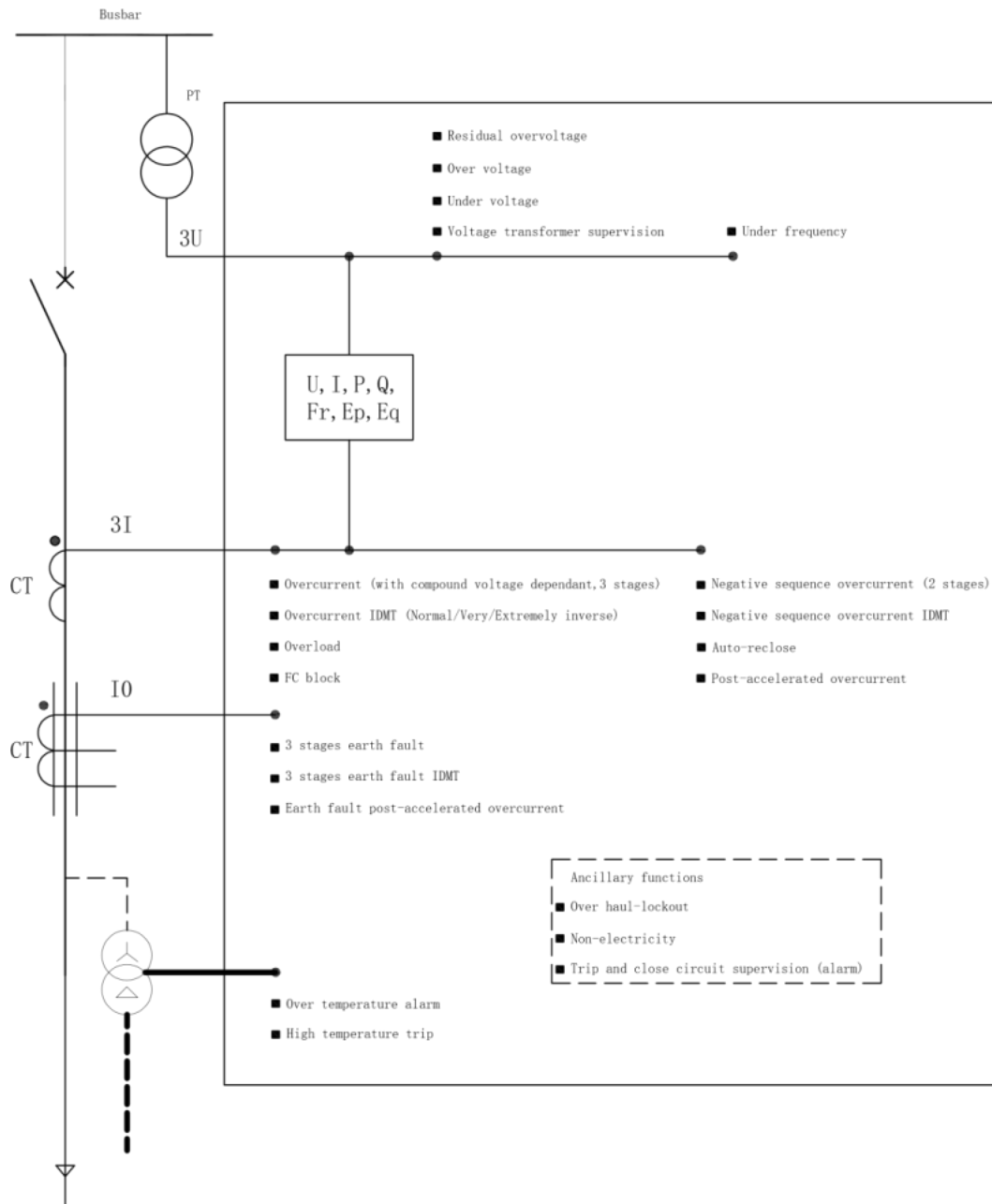

Fig. 5.3 AM2SE function diagram

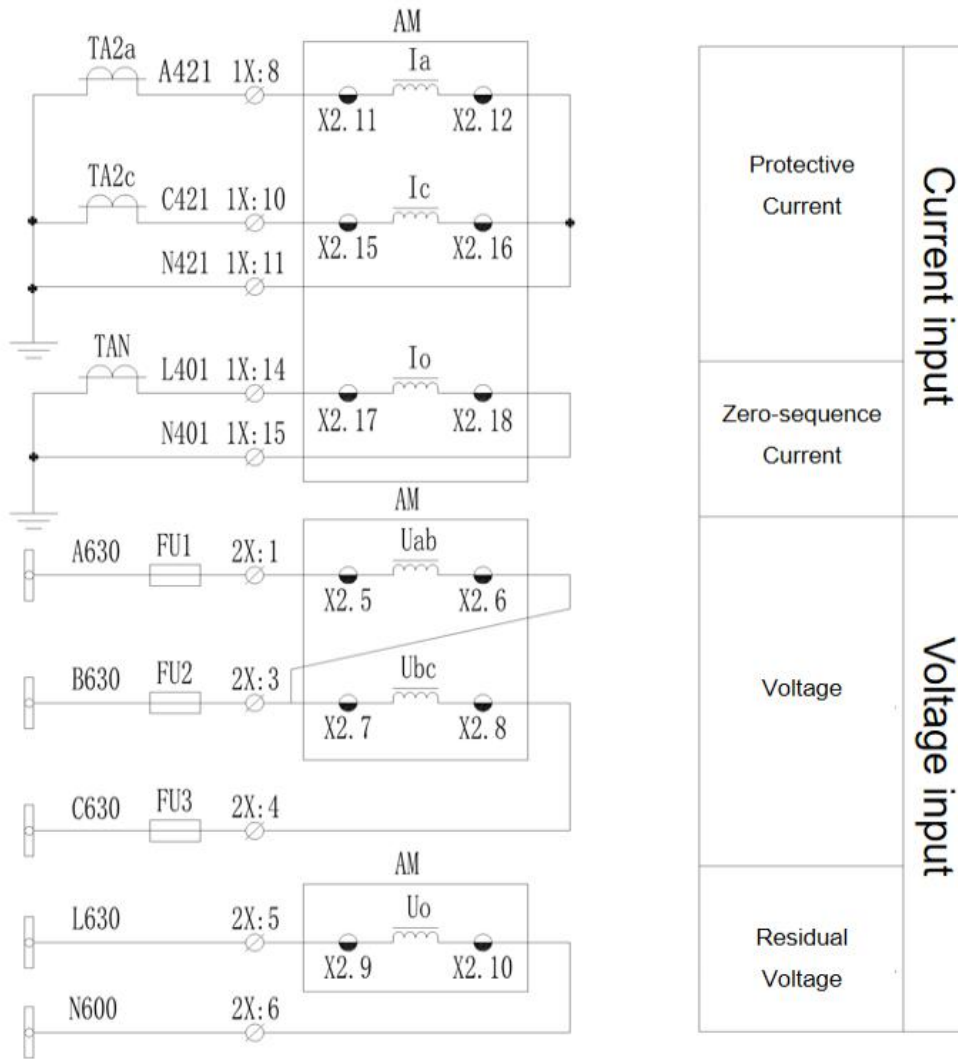

Fig.5.4 2PT & 2CT Wiring



## 6 Product Maintenance

The following table shows the common problems and treatment methods of the AM2SE during use.

Table 6.1 Common problems and treatment methods

Question	Possible Cause	Suggestion
Relay does not trip	<ol style="list-style-type: none"> <li>1. Corresponding function is not enabled.</li> <li>2. Conditions for closure.</li> </ol>	<ol style="list-style-type: none"> <li>1、 Set the corresponding protection enable on;</li> <li>2、 Check the blocking condition.</li> </ol>
Abnormal voltage display on the relay	The “PT mode” is different from the wiring.	Reset the “PT mode” according to the wiring.
Communication failure	<ol style="list-style-type: none"> <li>1. The polarity of communication cable is reversal.</li> <li>2. Communication parameter and protocol are inconformity.</li> <li>3. Communication cable break.</li> <li>4. Wrong communication address.</li> </ol>	<ol style="list-style-type: none"> <li>1、 Check the wiring.</li> <li>2、 Reset communication parameters and protocols.</li> <li>3、 Repair or replace the communication cable.</li> <li>4、 Reset the communication address in the “COMM” menu.</li> </ol>
No digital signaling displayed	No signal input to corresponding digital input.	Measure the voltage between the corresponding digital input and the common terminal of the relay. Check whether the voltage is normal.
Digital signaling names do not match the drawing	Digital signaling names have not been configured	Customize the digital input configuration in the setting menu according to the drawing
Breaker trips during energization	Magnetic inrush current from transformer energization causes protection mis-operation	Enable the second harmonic blocking function
Non-electrical protection does not trip	<ol style="list-style-type: none"> <li>1. The function is not enabled</li> <li>2. The correct digital input sequence number is not set</li> </ol>	<ol style="list-style-type: none"> <li>1. Enable the corresponding protection function in the setting table</li> <li>2. Customize the digital input configuration in the setting menu according to the drawing and set the correct digital input sequence number</li> </ol>

## Appendix A Setting value

AM2SE 定值表 AM2SE Setting value				
保护名称 Protection Function	定值名称 Value Name	默认值 Default	范围 Range	备注 Notice
	进线 PT 选择 In_PT Select	0	0~1	不带; 带 No; Yes
	CT 变比 CT	10	0.1~9999	
	PT 变比 PT	100	0.1~9999	
	电压接线方式 PT Mode	3PT	0~1	3PT; 2PT
	电流接线方式 CT Mode	3CT	0~1	3CT; 2CT
	跳闸展宽 Tripping pulse	0.15s	0~1	
	默认延时 Default delay	0.005s	0~0.04	
开入配置 Input.C [DI Configuration]	分合位采集 CB On/Off A. [ Circuit Breaker On/Off Acquisition ]	0	0~2	分合双点; 合位单点; 分位单点 CCB On/Off; CCB On; CCB Off [ Circuit Breaker On/Off; Circuit Breaker On; Circuit Breaker Off ]
	合位配置 CB On.C [ Circuit Breaker On Configuration ]	1	1~8	
	分位配置 CB Off.C [ Circuit Breaker Off Configuration ]	2	1~8	
	远方配置 Remote.C [ Remote Configuration ]	5	0~8	
	手动分闸配置 ManualTr.C	0	0~8	

	[ Manual Trip Configuration ]			
	手动合闸配置 ManualCl.C [ Manual Close Configuration ]	0	0~8	
	接地刀位置配置 Gro.S.C [ Ground Switch Configuration ]	6	0~8	
	弹簧未储能配置 Disch.C [ Discharge Configuration ]	4	0~8	
	闭锁重合闸配置 Bl.Re.C [ Block Auto-Reclose Configuration ]	0	0~8	
	低压阈值 U. Less [ Low voltage threshold ]	15V	1~200	低电压判据 Low voltage criterion
	相间低电压定值 U. Under [ Phase to phase low voltage value ]	70V	1~200	
	复合电压负序定值 U2	35V	1~200	
过流一段 3I>>> [50] [ Instantaneous overcurrent ]	过流一段投退 E.3I>>> [ Enable.3I>>> ]	0	0~1	退出；投入 Off;On
	一段经低压 E.3I>>>.U [ Enable.3I>>> .voltage ]	0	0~1	退出；投入 Off;On [ If enable 3I>>>.U, voltage conditions should be considered for overcurrent protection. When the smallest of the three line voltages is less than U.Under and greater than U.Less, the overcurrent protection DO is prepare work. ]

	过流一段定值 3I>>> [ 3I>>> value ]	10A	0.04~120	
	过流一段延时 3I>>>.T [ 3I>>> delay time ]	0s	0~60	
过流二段 3I>> [51] [ Time-limited overcurrent ]	过流二段投退 E.3I>> [ Enable.3I>> ]	0	0~1	退出; 投入 Off;On
	二段经低压 E.3I>>.U [ Enable.3I>> .voltage ]	0	0~1	退出; 投入 Off;On [ If enable 3I>>.U, voltage conditions should be considered for overcurrent protection. When the smallest of the three line voltages is less than U.Under and greater than U.Less, the overcurrent protection DO is prepare work. ]
	过流二段定值 3I>> [ 3I>> value ]	7.5A	0.04~120	
	过流二段延时 3I>>.T [ 3I>> delay time ]	0.2s	0~60	
过流三段 3I> [51] [ Definite time overcurrent ]	过流三段投退 E.3I> [ Enable.3I> ]	0	0~1	退出; 投入 Off;On
	过流三段方式 E.3I>.M [ Enable.3I> Mode]	0	0~1	告警; 跳闸 Alarm;Trip
	三段经低压 3I>.U [ Enable.3I> .voltage ]	0	0~1	退出; 投入 Off;On [ If enable 3I>.U, voltage conditions should be considered for overcurrent protection. When the

				smallest of the three line voltages is less than U.Under and greater than U.Less, the overcurrent protection DO is prepare work. ]
	过流三段定值 3I> [ 3I> value ]	7A	0.04~120	
	过流三段延时 3I>.T [ 3I> delay time ]	0.5s	0~60	
反时限过流 I> [51] [ Inverse time overcurrent (IDMT)]	反时限过流投退 E. I>.Inv [ Enable I> Inverse ]	0	0~1	退出; 投入 Off;On
	反时限经低压 E. I>.Inv.U [ Enable I>Inverse voltage ]	0	0~1	退出; 投入 Off;On [ If enable I>.Inv.U , voltage conditions should be considered for overcurrent protection. When the smallest of the three line voltages is less than U.Under and greater than U.Less, the overcurrent protection DO is prepare work. ]
	反时限启动电流 I>.Inv [ Inverse starting current ]	6A	0.04~120	
	反时限时间系数 I>.Inv.K [ Inverse time coefficient ]	0.1s	0~100	
	反时限曲线类型 I>.Inv.X [ Inverse curves type ]	0	0~2	一般; 非常; 极端 S1;S2;S3 [ Normal Inverse; Very Inverse; Extremely Inverse ]
	过负荷 [49F]	过负荷投退 E. I>Lo	0	0~1

Overload	[ Enable Overload ]			
	过负荷方式 E. I>Lo.M [ Enable Overload Mode]	0	0~1	告警; 跳闸 Alarm; Trip
	过负荷定值 I>Lo [ Overload value ]	6.5A	0.04~120	
	过负荷延时 I>Lo.T [ Overload delay time ]	1s	0~999	
I0 过流一段 I0>>> [50N] [ Instantaneous ground fault overcurrent ]	I0 过流一段投退 E. I0>>> [ Enable I0>>> ]	0	0~1	退出; 投入 Off; On
	I0 过流一段定值 I0>>> [ I0>>> value ]	3A	0.04~120	
	I0 过流一段延时 I0>>>T [ I0>>> delay time ]	5s	0~60	
I0 过流二段 I0>> [51N] [ Time limited ground fault overcurrent ]	I0 过流二段投退 E. I0>> [ Enable I0>> ]	0	0~1	退出; 投入 Off; On
	I0 过流二段方式 E. I0>>M [ Enable I0>> Mode ]	0	0~1	告警; 跳闸 Alarm; Trip
	I0 过流二段定值 I0>> [ I0>> value ]	2A	0.04~120	
	I01 过流二段延时 I0>>T [ I0>> delay time ]	10s	0~999	
I0 过流三段 I0> [51N] [ Definite time ground fault overcurren ]	I0 过流三段投退 E. I0> [ Enable I0> ]	0	0~1	退出; 投入 Off; On
	I0 过流三段方式 E. I0>M [ Enable I0> Mode ]	0	0~1	告警; 跳闸 Alarm; Trip
	I0 过流三段定值 I0> [ I0> value ]	2A	0.04~120	
	I0 过流三段延时 I0>T	10s	0~999	

	[ I0>> delay time ]			
I0 后加速过流 PostAccelerating I0> [ PostAccelerating Ground fault overcurrent ]	I0 后加速过流投退 E. I0>P [ Enable I0>P ]	0	0~1	退出; 投入 Off;On
	I0 后加速过流定值 I0>P [ I0>P value ]	3A	0.04~120	
	I0 后加速过流延时 I0>P.T [ I0>P delay time ]	5s	0~60	
I0 反时限过流 Inv. Time I0> [51N] [ Inverse time ground fault ]	I0 反时限投退 E. I0.Inv [ Enable I0.Inv ]	0	0~1	退出; 投入 Off;On
	I0 反时限启动值 I0.Inv [ I0.Inv starting value ]	6A	0.04~120	
	I0 反时限系数 I0.Inv.K [ I0.Inv time coefficient ]	0.1s	0~100	
	I0 反时限曲线 I0.Inv.X [ I0.Inv curves type ]	0	0~2	一般; 非常; 极端 S1;S2;S3 [ Normal Inverse; Very Inverse; Extremely Inverse ]
低电压保护 [27] Low Voltage Protection	低电压保护投退 E. LVP [ Enable LVP ]	0	0~1	退出; 投入 Off;On
	低电压方式 E. LVP.M [ Enable LVP Mode ]	0	0~1	告警; 跳闸 Alarm; Trip
	低电压保护定值 U. LVP [ LVP value ]	50V	1~200	
	低电压保护延时 LVP.T [ LVP delay time ]	5s	0~60	
	无流闭锁投退 E. LVP.I.B [ Enable LVP current block ]	0	0~1	退出; 投入 Off;On [ If enable LVP.I.B, when the current is less than I.None, low voltage protection will

				be blocked. ]
	无流定值 I. None [Current none]	0.2A	0.04~120	[ Less than I.None means that there is no current ]
	PT 断线闭锁投退 E. PT.B [ Enable PT break block]	1	0~1	退出; 投入 Off;On [ When PT break occurs, the relay will send an alarm signal and lock out the low voltage protection.]
	合位允许投退 E.CB.On.B [ Enable circuit breaker on block ]	0	0~1	退出; 投入 Off;On
	低电压阈值投退 E. LVTHr. [ Enable LVP threshold ]	1	0~1	退出; 投入 Off;On [ If enable LVTHr. , when the voltage is greater than U.None and less than U.LVP , Low Voltage protection will act. If exit LVTHr. , Low voltage protection is Loss voltage protection.]
过电压保护 [59] Over Voltage Protection	过电压保护投退 E.OVP [ Enable OVP ]	0	0~1	退出; 投入 Off;On
	过电压方式 E.OVP.M [ Enable OVP Mode ]	0	0~1	告警; 跳闸 Alarm; Trip
	过电压保护定值 U. OVP [ OVP value ]	120V	1~200	
	过电压保护延时 OVP.T [ OVP delay time ]	10s	0~999	
零序过压保护 U0 over voltage protection	零序过压投退 E.U0.OVP [ Enable U0.OVP ]	0	0~1	退出; 投入 Off;On



[59N] [ Residual over voltage ]	零序过压方式 E.U0.OVP.M [ Enable U0.OVP Mode ]	0	0~1	告警; 跳闸 Alarm; Trip
	零序过压定值 U0.OVP [ U0 OVP value ]	110V	1~200	
	零序过压延时 U0.OVP.T [ U0 OVP delay time ]	10s	0~999	
控故障告警 Trip and close circuit supervision alarm	控故障告警投退 E.CB.A [ Enable Trip and close circuit supervision alarm]	0	0~1	退出; 投入 Off; On
	控故障告警延时 CB.A.T [ Trip and close circuit supervision alarm delay time]	10s	0~999	
PT 断线告警 PT break Alarm	PT 断线告警投退 E.PtBr.A [ Enable PtBr.A]	0	0~1	退出; 投入 Off; On
	无压定值 U. None [ Voltage None ]	15V	1~200	[ Less than U.None means that there is no voltage ]
	PT 断线负序电压 U2.Pt [PT break negative sequence voltage ]	35V	1~200	
	PT 断线告警延时 PtBr.T [ PtBr. delay time]	3s	0~999	
超温保护 High Temperature	超温配置 HTem.C [ HTem. Configuration ]	8	0~8	
	超温保护投退 E.HTem [ Enable HTem.]	0	0~1	退出; 投入 Off; On
	超温方式 E.HTem.M [ Enable HTem. Mode ]	0	0~1	告警; 跳闸 Alarm; Trip
	超温保护延时 HTem.T	5s	0~999	

	[ HTem. delay time ]			
变压器门开保护 Transformer door opening protection	变压器门开配置 DoOp.C [ Door open configuration ]	0	0~8	
	变压器门开投退 E.DoOp [ Enable DoOp.]	0	0~1	退出; 投入 Off;On
	变压器门开方式 E.DoOp.M [ Enable DoOp. Mode]	0	0~1	告警; 跳闸 Alarm;Trip
	变压器门开延时 DoOp.T [ DoOp. delay time]	5s	0~999	
高温保护 Over Temperatation	高温配置 OTem.C [ OTem. Configuration ]	7	0~8	
	高温保护投退 E.OTem. [ Enable OTem.]	0	0~1	退出; 投入 Off;On
	高温方式 E.OTem.M [ Enable OTem. Mode]	0	0~1	告警; 跳闸 Alarm;Trip
	高温保护延时 OTem.T [OTem.delay time]	5s	0~999	
重瓦斯保护 Severe Gas	重瓦斯配置 SGas.C [ Severe Gas configuration ]	0	0~8	
	重瓦斯保护投退 E.SGas. [ Enable SGas.]	0	0~1	退出; 投入 Off;On
	重瓦斯方式 E.SGas.M [ Enable SGas. Mode ]	0	0~1	告警; 跳闸 Alarm;Trip
	重瓦斯保护延时 SGas.T [ SGas. delay time]	5s	0~999	
轻瓦斯保护 Light Gas	轻瓦斯配置 LGas.C [ Light Gas configuration ]	0	0~8	
	轻瓦斯保护投退 E.LGas.	0	0~1	退出; 投入 Off;On

	[ Enable LGas. ]			
	轻瓦斯方式 E.LGas.M [ Enable LGas. Mode ]	0	0~1	告警; 跳闸 Alarm; Trip
	轻瓦斯保护延时 LGas.T [ LGas. delay time ]	5s	0~999	
温控器故障保护 Thermostat fault protection	温控器故障配置 Th.F.C [ Thermostat fault configuration ]	0	0~8	
	温控器故障投退 E.Th.F. [ Enable Th.F. ]	0	0~1	退出; 投入 Off; On
	温控器故障方式 E.Th.F.M [ Enable Th.F. Mode ]	0	0~1	告警; 跳闸 Alarm; Trip
	温控器故障延时 Th.F.T [ Th.F. delay time ]	5s	0~999	
重合闸 [79] Auto-reclose	重合闸投退 E.Reclose [ Enable Auto-reclose ]	0	0~1	退出; 投入 Off; On
	重合闸充电延时 Rec.C.T [ Auto-reclose charge delay time ]	15s	0~60	
	重合闸延时 Reclose.T [ Auto-reclose delay time ]	5s	0~60	
	保护重合返回延时 T.R.T [ Auto-reclose return delay time ]	30s	0~999	
	重合闸方式 Reclose.X [ Auto-reclose mode ]	0	0~1	不检; 检无压 Not Check; Check
	不对应重合投退 E.nonP. [ Enable non-position auto-reclose ]	0	0~1	退出; 投入 Off; On [ If enable nonP. , both the protection action and circuit breaker

				"steal trip" can act auto-reclose.]
后加速过流 Post Accelerating overcurrent	后加速过流投退 E. I>P [ Enable post accelerating overcurrent ]	0	0~1	退出; 投入 Off;On
	后加速经低压 E. I>P.U [ Enable I>P voltage ]	0	0~1	退出; 投入 Off;On [ If enable I>P.U , voltage conditions should be considered for overcurrent protection. When the smallest of the three line voltages is less than U.Under and greater than U.Less, the overcurrent protection DO is prepare work. ]
	后加速过流定值 I>P [ Post accelerating value ]	6.5A	0.04~120	
	后加速过流延时 I>P.T [ Post accelerating delay time]	0s	0~60	
低频减载 [81U] Under-Frequency Protection	低频减载投退 E.UnderFr. [ Enable Under Frequency ]	0	0~1	退出; 投入 Off;On
	低压闭锁 E. UnderFr.U [ Enable UnderFr. voltage]	0	0~1	退出; 投入 Off;On [ Ua is lower than U.B, while the zero sequence voltage 3U0 is lower than 8V, or PT break , Under frequency function will be lockout.]
	欠流闭锁 E.UnderFr.I [ Enable UnderFr. current ]	0	0~1	退出; 投入 Off;On [ When the maximum current value is lower than I.B,Under

				frequency function will be lockout.]
	滑差闭锁 E.UnderFr.dHz. [ Enable UnderFr.dHz]	0	0~1	退出; 投入 Off;On [ When df/dt lower than dHz.B, Under frequency function will be lockout.]
	低频减载定值 UnderFr. [ UnderFr. value ]	49Hz	45~60	
	低频减载延时 UnderFr.T [ UnderFr. delay time ]	5s	0~60	
	滑差闭锁值 dHz.B [ UnderFr.dHz. value]	0.1	0.01~100	
	欠流闭锁值 I. B [ UnderFr.I value]	5A	0.2~120	
	低压闭锁值 U. B [ UnderFr.U value]	50V	0~200	
非电量 1 保护 Non-electric1 protection	非电量 1 配置 Non-el1.C [ Non-electric1 configuration ]	0	0~8	
	非电量 1 投退 E. Non-el1 [ Enable Non-el1]	0	0~1	退出; 投入 Off;On
	非电量 1 方式 E. Non-el1.M [ Enable Non-el1. Mode]	0	0~1	告警; 跳闸 Alarm; Trip
	非电量 1 延时 Non-el1.T [ Non-el1. delay time]	5s	0~999	
非电量 2 保护 Non-electric2 protection	非电量 2 配置 Non-el2.C [ Non-electric2 configuration ]	0	0~8	
	非电量 2 投退 E. Non-el2	0	0~1	退出; 投入 Off;On

	[ Enable Non-el2 ]			
	非电量 2 方式 E. Non-el2.M [ Enable Non-el2. Mode]	0	0~1	告警; 跳闸 Alarm; Trip
	非电量 2 延时 Non-el2.T [ Non-el2. delay time]	5s	0~999	
非电量 3 保护 Non-electric3 protection	非电量 3 配置 Non-el3.C [ Non-electric3 configuration ]	0	0~8	
	非电量 3 投退 E. Non-el3 [ Enable Non-el3 ]	0	0~1	退出; 投入 Off; On
	非电量 3 方式 E. Non-el3.M [ Enable Non-el3. Mode]	0	0~1	告警; 跳闸 Alarm; Trip
	非电量 3 延时 Non-el3.T [ Non-el3. delay time]	5s	0~999	
负序过流一段 I2>>> [46] [ Negative sequence overcurrent ]	负序一段投退 E. I2>>> [ Enable I2>>> ]	0	0~1	退出; 投入 Off; On
	负序一段定值 I2>>> [ I2>>> value ]	10A	0.04~120	
	负序一段延时 I2>>>.T [ I2>>> delay time ]	5s	0~60	
负序过流二段 I2>> [46] [ Negative sequence overcurrent ]	负序二段投退 E. I2>> [ Enable I2>> ]	0	0~1	退出; 投入 Off; On
	负序二段方式 E. I2>>.M [ Enable I2>> Mode ]	0	0~1	告警; 跳闸 Alarm; Trip
	负序二段定值 I2>> [ I2>> value ]	9A	0.04~120	
	负序二段延时 I2>>.T [ I2>> delay time ]	10s	0~999	
负序反时限过流	负序反时限投退	0	0~1	退出; 投入

I2.Inv.Tr [46] [ Negative sequence inverse overcurrent(IDMT)]	E. I2>Inv [ Enable I2>Inv ]			Off;On
	负序反时限电流 I2>Inv [ I2>Inv value ]	6A	0.04~120	
	负序反时限系数 I2>Inv.K [ I2>Inv. time coefficient ]	0.1s	0~100	
	负序反时限曲线 I2>Inv.X [ I2>Inv. curves type ]	0	0~2	一般；非常；极端 S1;S2;S3 [ Normal Inverse; Very Inverse; Extremely Inverse ]
FC 配合的过流闭锁 功能 [86] FC Block	FC 闭锁投退 E. FCBlock [ Enable FC Block ]	0	0~1	退出；投入 Off;On [ When the fault current is greater than FCBlock.I, the relay's DO will be lockout,in order to ensure that the fuse is first blown.]
	FC 闭锁电流定值 FCBlock.I [ FC Block current value ]	10A	0.04~120	
	FC 闭锁延时 FCBlock.T [ FC Block delay time ]	5s	0~60	
遥信名字配置 Name.C [ Remote name configuration ]	实遥信 01 名配置 Name01.C [ Remote 01 name configuration]	0	0~9999	
	实遥信 02 名配置 Name02.C [ Remote 02 name configuration]	0	0~9999	
	实遥信 03 名配置 Name03.C [ Remote 03 name configuration]	0	0~9999	
	实遥信 04 名配置	0	0~9999	

	Name04.C [ Remote 04 name configuration]			
	实遥信 05 名配置 Name05.C [ Remote 05 name configuration]	0	0~9999	
	实遥信 06 名配置 Name06.C [ Remote 06 name configuration]	0	0~9999	
	实遥信 07 名配置 Name07.C [ Remote 07 name configuration]	0	0~9999	
	实遥信 08 名配置 Name08.C [ Remote 08 name configuration]	0	0~9999	
2 次谐波闭锁 Second Harmonic Blocking	二次谐波闭锁投退 E.SHB. [ Enable Second harmonic blocking ]	0	0~1	退出; 投入 Off;On
	二次谐波闭锁定值 SHB. [ SHB. value ]	10%	0~100	
	涌流持续时间 Inrush.C.T [ Inrush time of duration]	5s	0~999	
压力释放 Pressure Release	压力释放配置 Pre.Re.C [ Pressure Release configuration ]	0	0~8	
	压力释放投退 E. Pre.Re [ Enable Pre.Re ]	0	0~1	退出; 投入 Off;On
	压力释放方式 E. Pre.Re.M [ Enabke Pre.Re. Mode ]	0	0~1	告警; 跳闸 Alarm; Trip
	压力释放延时 Pre.Re.T [ Pre.Re. delay time ]	5s	0~999	



负控保护 Negative Control	负控保护配置 Ne.Con.C [ Negative Control configuration ]	0	0~8	
	负控保护投退 E. Ne.Con [ Enable Ne.Con. ]	0	0~1	退出; 投入 Off;On
	负控保护方式 E. Ne.Con.M [ Enable Ne.Con. Mode ]	0	0~1	告警; 跳闸 Alarm; Trip
	负控保护延时 Ne.Con.T [ Ne.Con. delay time ]	5s	0~999	
检修状态闭锁 [86] Overhaul lockout	检修状态配置 Ma.C [ Overhaul lockout configuration ]	0	0~8	
	检修状态闭锁通讯投退 E. M.BC [ Enable Overhaul lockout communication ]	0	0~1	退出; 投入 Off;On
	检修状态闭锁出口投退 E. M.BE [ Enable Overhaul lockout DO ]	0	0~1	退出; 投入 Off;On
	断路器动作时间 Cir.Br.T [Circuit Break time]	0.3s	0~999	
	重合闸充电返回 T Rec.C.RT [Auto-reclose charge return time ]	1s	0~999	
	弹簧未储能延时 Sp.En.D. [Discharge delay time ]	0s	0~999	
	I0 参与 2CT 计算 I0 P 2CT [ I0 participate in 2CT calculation]	0	0~1	保护 CT 不同变比; 保护 CT 同变比 CT D.R; CT S.R [protective CT is different from zero sequence CT] ; [protective CT is same

				as zero sequence CT]  [ When there are 2CT, wheather zero sequence current is involved in the calculation of Ib.]
	过量返回系数 Excess R.C [ Excess Return Coefficient ]	0.95	0.001~2	
	欠量返回系数 Under R.C [ Under Return Coefficient ]	1.05	0.001~2	

Appendix B Remote address table

名称 Name	代码 Code	名称 Name	代码 Code
状态遥信量 Spare state			
备用状态量遥信 1 Spare state1	1001	备用状态量遥信 2 Spare state2	1002
备用状态量遥信 3 Spare state3	1003	备用状态量遥信 4 Spare state4	1004
备用状态量遥信 5 Spare state5	1005	备用状态量遥信 6 Spare state6	1006
备用状态量遥信 7 Spare state7	1007	备用状态量遥信 8 Spare state8	1008
备用状态量遥信 9 Spare state9	1009	备用状态量遥信 10 Spare state10	1010
备用状态量遥信 11 Spare state11	1011	备用状态量遥信 12 Spare state12	1012
备用状态量遥信 13 Spare state13	1013	备用状态量遥信 14 Spare state14	1014
备用状态量遥信 15 Spare state15	1015	备用状态量遥信 16 Spare state16	1016
备用状态量遥信 17 Spare state17	1017	备用状态量遥信 18 Spare state18	1018
备用状态量遥信 19 Spare state19	1019	备用状态量遥信 20 Spare state20	1020
1#PT 手车工作位置 1#PT Handcart Work Position 1#PT W.P	1021	2#PT 手车工作位置 2#PT Handcart Work Position 2#PT W.P	1022
1#PT 手车试验位置 1#PT Handcart Test Position 1#PT T.P	1023	2#PT 手车试验位置 2#PT Handcart Test Position 2#PT T.P	1024
1#隔离手车工作位 1#Isolation Handcart Work Position 1#Iso.W.P	1025	2#隔离手车工作位 2#Isolation Handcart Work Position 2#Iso.W.P	1026
1#隔离手车试验位 1#Isolation Handcart Test Position 1#Iso.T.P	1027	2#隔离手车试验位 2#Isolation Handcart Test Position 2#Iso.T.P	1028
1QF 隔离刀 1QF Isolation Switch 1QF Iso.K	1029	2QF 隔离刀 2QF Isolation Switch 2QF Iso.K	1030

1QF 位置 1QF Circuit Breaker On 1QF On	1031	2QF 位置 2QF Circuit Breaker On 2QF On	1032
1 号主供跳位警报 1QF Circuit Breaker Off Alarm 1QF Off A.	1033	2 号主供跳位警报 2QF Circuit Breaker Off Alarm 2QF Off A.	1034
345QJ 分位 345QJ Circuit Breaker Off 345QJ Off	1035	I 母 PT 工作位置 I-section busbar PT Handcart Work Position I Bus PT W.P	1036
II 母 PT 工作位置 II-section busbar PT Handcart Work Position II Bus PT W.P	1037	I 母 PT 试验位置 I-section busbar PT Handcart Test Position I Bus PT T.P	1038
II 母 PT 试验位置 II-section busbar PT Handcart Test Position II Bus PT T.P	1039	PT 避雷器手车位置 PT Arrester Handcart Work Position PT Arrester W.P	1040
PT 柜隔离手车工作位 PT Isolation Handcart Work Position PT Iso.W.P	1041	PT 手车工作位置 PT Handcart Work Position PT W.P	1042
PT 手车试验位置 PT Handcart Test Position PT T.P	1043	PT 手车位置 PT Handcart Position PT Position	1044
本段 PT 柜控制开关 PT Control Switch Pri.Sec.PT Cont.Swit.	1045	本段计量车位置 Metering Handcart Position Pri.Sec.Meter.P	1046
本段进线隔离车位置 In-coming Isolation Handcart Position Pri.Sec.In-com.Iso.P	1047	本段母联隔离车位置 Bus Isolation Handcart Position Pri.Sec.Bus Iso.P	1048
本柜 PT 手车工作位 PT Handcart Work Position Pri.Sec.PT W.P	1049	避雷器手车位置 Arrester Handcart Position Arrester Position	1050
避雷手车工作位 Arrester Handcart Work Position Arrester W.P	1051	储能回路直流消失 Storage Circuit DC Loss Storage Cir.DC Loss	1052
弹簧未储能 Discharge	1053	弹簧已储能 Stored Spring	1054
低压侧隔开状态 Low Voltage Separation State LV Separation State	1055	非保证负荷 1 Non guarant load1	1056

非保证负荷 2 Non guarant load2	1057	非保证负荷 3 Non guarant load3	1058
非保证负荷 4 Non guarant load4	1059	非保证负荷 5 Non guarant load5	1060
非保证负荷 6 Non guarant load6	1061	非保证负荷 7 Non guarant load7	1062
非保证负荷 8 Non guarant load8	1063	非保证负荷 9 Non guarant load9	1064
非保证负荷 10 Non guarant load10	1065	非保证负荷 11 Non guarant load11	1066
非保证负荷 12 Non guarant load12	1067	非保证负荷 13 Non guarant load13	1068
非保证负荷 14 Non guarant load14	1069	非保证负荷 15 Non guarant load15	1070
非保证负荷 16 Non guarant load16	1071	非保证负荷 17 Non guarant load17	1072
非保证负荷 18 Non guarant load18	1073	非保证负荷 19 Non guarant load19	1074
非保证负荷 20 Non guarant load20	1075	分段隔离柜手车位置 Subsection Isolation Handcart Position Subsect.Iso.P	1076
分段隔离手车工作位 Subsection Isolation Handcart Work Position Subsect.Iso.W.P	1077	分位 Circuit Breaker Off CB Off	1078
合位 Circuit Breaker On CB On	1079	负荷开关 Load Switch	1080
复位按钮 Reset Button	1081	高压侧隔离状态 High Voltage Separation State HV Separation State	1082
隔离刀分位 Isolation Switch Off Iso.K.Off	1083	隔离刀合位 Isolation Switch On Iso.K.On	1084
隔离开关合位 Isolation Switch On Iso.Switch On	1085	隔离刀位置 Isolation Switch Position Iso.K.P	1086
隔离刀工作位置 Isolation Switch Work Position Iso.K.W.P	1087	隔离刀试验位置 Isolation Switch Test Position Iso.K.T.P	1088
隔离手车工作位置	1089	隔离手车试验位置	1090

Isolation Handcart Work Position Iso.W.P		Isolation Handcart Test Position Iso.T.P	
隔离手车位置 Isolation Handcart Position Iso.P	1091	急停信号 Emergency stop signal Emergency stop sig.	1092
计量断路器分位 Metering Circuit Breaker Off Meter.CB Off	1093	计量断路器合位 Metering Circuit Breaker On Meter.CB On	1094
计量柜弹簧未储能 Metering Discharge Meter.Discharge	1095	计量手车工作位置 Metering Handcart Work Position Meter.W.P	1096
计量手车试验位置 Metering Handcart Test Position Meter.T.P	1097	计量手车位置 Metering Handcart Position Meter.P	1098
接地刀闸 GroundSwitch	1099	进线负荷开关 In-coming Load Switch In-com.Load Switch	1100
进线隔离柜微断跳闸 In-coming Isolation Micro Circuit Breaker Trip In-com.Iso.Micro.CB.T	1101	进线隔离手车工作位置 In-coming Isolation Handcart Work Position In-com.Iso.W.P	1102
进线隔离手车试验位置 In-coming Isolation Handcart Test Position In-com.Iso.T.P	1103	进线手车工作位 In-coming Handcart Work Position In-com.W.P	1104
进线微断跳闸 In-coming Micro Circuit Breaker Trip In-com.Micro.T	1105	母联断路器分位 Bus Circuit Breaker On Bus CB On	1106
母联断路器合位 Bus Circuit Breaker Off Bus CB Off	1107	母联隔离手车工作 Bus Isolation Handcart Work Position Bus Iso.W.P	1108
母联隔离手车位 Bus Isolation Handcart Position Bus Iso.P	1109	母线 PT 柜隔离刀合闸 Bus PT Isolation Switch On Bus PT Iso.K.On	1110
母线 PT 手车工作位 Bus PT Handcart Work Position Bus PT W.P	1111	熔断器手车工作位置 Fuse Handcart Work Position Fuse W.P	1112
熔断器手车试验位置 Fuse Handcart Test Position Fuse T.P	1113	上隔离 Upper Isolation Upper Iso.	1114
上隔离合位	1115	上隔离开关合位	1116

Upper Isolation On Upper Iso.On		Upper Isolation Switch On Upper Iso.Switch On	
手车工作位置 Handcart Work Position Work Posi.	1117	手车试验位置 Handcart Test Position Test Posi.	1118
手动分闸 ManualTrip	1119	手动合闸 ManualClose	1120
所用变工作位置 Transformer Handcart Work Position T.W.P	1121	所用变试验位置 Transformer Handcart Test Position T.T.P	1122
跳位监视 Trip Supervision	1123	微型断路器跳闸 Micro Circuit Breaker Trip Micro.CB.T	1124
下 PT 手车工作位 Lower PT Handcart Work Position Lower PT W.P	1125	下隔离 Lower Isolation Lower Iso.	1126
下接地 Lower Ground	1127	信号复归 ResetSignal	1128
压变工作位置 PT Handcart Work Position Pre.Trans.W.P	1129	压变试验位置 PT Handcart Test Position Pre.Trans.T.P	1130
远方 Remote	1131	远方复归 Remote Reset	1132
触头手车工作位置 Contact Handcart Work Position Contact W.P	1133	交直流空开跳闸 AC/DC Micro Circuit Breaker Trip AC/DC Air Switch.T	1134
操作回路跳闸 Operation Circuit Trip Operation Cir.T	1135	电压回路跳闸 Voltage Circuit Trip Voltage Cir.T	1136
隔离开关分位 Isolation Switch Off Iso.Switch Off	1137	PT 隔离开关位置 PT Isolation Switch Position PT Iso.Switch.P	1138
计量 PT 手车工作位置 Metering PT Handcart Work Position Meter.PT W.P	1139	操显装置告警 Manipulation Device Alarm Oper.And Disp.Devi.A	1140
接地手车工作 Ground Handcart Work Position Ground W.P	1141	接地手车试验 Ground Handcart Test Position Ground T.P	1142
避雷手车试验位 Arrester Handcart Test Position Arrester T.P	1143	母线电压失压 Bus Voltage Loss B.Vol.Lo	1144
储能电源失电	1145	断路器温度报警	1146

Power Loss		Circuit Breaker Temperature Alarm Cir.Temp.A	
油机并车屏联跳 Oil Engine Parallel Intertrip Oil.Eng.Par.Joint.T	1147	I/II 段失压跳闸信号 I/II Loss Voltage Trip Signal I/II LV.T Sig.	1148
I/II 段电压并列信号 I/II Voltage Parallel Signal I/II Vol.Par.Sig.	1149	进线侧电源失电 In-coming Power Loss In-com.Power Loss	1150
本段 PT 断线信号 PT Break Signal Pri.Sec.PT Break Sig.	1151	本段母线退出信号 Bus Exit Signal Pri.Sec.Bus Exit Sig.	1152
联络手车工作 Busbar Handcart Work Position Liaison W.P	1153	联络手车试验 Busbar Handcart Test Position Liaison T.P	1154
下 PT 手车试验位 Lower PT Handcart Test Position Lower PT T.P	1155	母线接地信号 Ground Bus Signal	1156
电压不平衡 Unbalance Voltage	1157	熔断器开关 Fuse Switch	1158
非电量遥信 Non-electricity			
备用非电量遥信 1 Spare Non-electricity 1 Spare Non-elec.1	2001	备用非电量遥信 2 Spare Non-electricity 2 Spare Non-elec.2	2002
备用非电量遥信 3 Spare Non-electricity 3 Spare Non-elec.3	2003	备用非电量遥信 4 Spare Non-electricity 4 Spare Non-elec.4	2004
备用非电量遥信 5 Spare Non-electricity 5 Spare Non-elec.5	2005	备用非电量遥信 6 Spare Non-electricity 6 Spare Non-elec.6	2006
备用非电量遥信 7 Spare Non-electricity 7 Spare Non-elec.7	2007	备用非电量遥信 8 Spare Non-electricity 8 Spare Non-elec.8	2008
备用非电量遥信 9 Spare Non-electricity 9 Spare Non-elec.9	2009	备用非电量遥信 10 Spare Non-electricity 10 Spare Non-elec.10	2010
备用非电量遥信 11 Spare Non-electricity 11 Spare Non-elec.11	2011	备用非电量遥信 12 Spare Non-electricity 12 Spare Non-elec.12	2012
备用非电量遥信 13 Spare Non-electricity 13 Spare Non-elec.13	2013	备用非电量遥信 14 Spare Non-electricity 14 Spare Non-elec.14	2014



备用非电量遥信 15 Spare Non-electricity 15 Spare Non-elec.15	2015	备用非电量遥信 16 Spare Non-electricity 16 Spare Non-elec.16	2016
备用非电量遥信 17 Spare Non-electricity 17 Spare Non-elec.17	2017	备用非电量遥信 18 Spare Non-electricity 18 Spare Non-elec.18	2018
备用非电量遥信 19 Spare Non-electricity 19 Spare Non-elec.19	2019	备用非电量遥信 20 Spare Non-electricity 20 Spare Non-elec.20	2020
高温 Over Temperature OverTemp.	2021	超温 High Temperature HighTemp.	2022
转速低 Low Speed	2023	转速高 High Speed	2024
轻瓦斯 SlightGas	2025	重瓦斯 SevereGas	2026
油位高 High Oil Level	2027	油位低 Low Oil Level	2028
压力释放 Pressure Release PressureRele.	2029	温控器故障 Temperature Controller Failure Therm.Fa.	2030
热复归 HeatRecovery	2031	门控跳 Door Open Trip Door Control.T	2032
门禁跳闸 Access Control Trip Access Control.T	2033	隔离手车连跳 Isolation Handcart Intertrip Iso.Handcart.T	2034
高侧网门 High side net-door	2035	低侧网门 Low side net-door	2036
感烟器报警 Smoke Detector Alarm Smoke Detector.A	2037	负控跳闸 Load Control Trip Nega.Control.T	2038
变压器门开 DoorOpen	2039	非电量 1 Non-electricity 1 Non-elec.1	2040
非电量 2 Non-electricity 2 Non-elec.2	2041	非电量 3 Non-electricity 3 Non-elec.3	2042
非电量 4 Non-electricity 4 Non-elec.4	2043	非电量 5 Non-electricity 5 Non-elec.5	2044
非电量 6	2045	非电量 7	2046

Non-electricity 6 Non-elec.6		Non-electricity 7 Non-elec.7	
非电量 8 Non-electricity 8 Non-elec.8	2047	非电量 9 Non-electricity 9 Non-elec.9	2048
非电量 10 Non-electricity 10 Non-elec.10	2049	非电量 11 Non-electricity 11 Non-elec.11	2050
非电量 12 Non-electricity 12 Non-elec.12	2051	非电量 13 Non-electricity 13 Non-elec.13	2052
非电量 14 Non-electricity 14 Non-elec.14	2053	非电量 15 Non-electricity 15 Non-elec.15	2054
非电量 16 Non-electricity 16 Non-elec.16	2055	非电量 17 Non-electricity 17 Non-elec.17	2056
非电量 18 Non-electricity 18 Non-elec.18	2057	非电量 19 Non-electricity 19 Non-elec.19	2058
非电量 20 Non-electricity 20 Non-elec.20	2059	计量门 1 跳闸 Meter-door 1 Trip Meter-door1.T	2060
计量门 2 跳闸 Meter-door 2 Trip Meter-door2.T	2061	计量门 3 跳闸 Meter-door 3 Trip Meter-door3.T	2062
计量门 4 跳闸 Meter-door 4 Trip Meter-door4.T	2063	计量门 5 跳闸 Meter-door 5 Trip Meter-door5.T	2064
计量门 6 跳闸 Meter-door 6 Trip Meter-door6.T	2065	计量门 7 跳闸 Meter-door 7 Trip Meter-door7.T	2066
计量门 8 跳闸 Meter-door 8 Trip Meter-door8.T	2067	计量门 9 跳闸 Meter-door 9 Trip Meter-door9.T	2068
计量门 10 跳闸 Meter-door 10 Trip Meter-door10.T	2069	计量门 11 跳闸 Meter-door 11 Trip Meter-door11.T	2070
计量门 12 跳闸 Meter-door 12 Trip Meter-door12.T	2071	计量门 13 跳闸 Meter-door 13 Trip Meter-door13.T	2072
计量门 14 跳闸	2073	计量门 15 跳闸	2074

Meter-door 14 Trip Meter-door14.T		Meter-door 15 Trip Meter-door15.T	
计量门 16 跳闸 Meter-door 16 Trip Meter-door16.T	2075	计量门 17 跳闸 Meter-door 17 Trip Meter-door17.T	2076
计量门 18 跳闸 Meter-door 18 Trip Meter-door18.T	2077	计量门 19 跳闸 Meter-door 19 Trip Meter-door19.T	2078
计量门 20 跳闸 Meter-door 20 Trip Meter-door20.T	2079	负控保护 Load Control Protection Nega.Control.P	2080
弧光保护 Arc flash Protection Arc.P	2081	5 次 A 相电容故障 5th A Phase Capacitor Failure 5th A p.Capacitor.F	2082
5 次 B 相电容故障 5th B Phase Capacitor Failure 5th B p.Capacitor.F	2083	5 次 C 相电容故障 5th C Phase Capacitor Failure 5th C p.Capacitor.F	2084
7 次 A 相电容故障 7th A Phase Capacitor Failure 7th A p.Capacitor.F	2085	7 次 B 相电容故障 7th B Phase Capacitor Failure 7th B p.Capacitor.F	2086
7 次 C 相电容故障 7th C Phase Capacitor Failure 7th C p.Capacitor.F	2087		
压板遥信 Plate			
备用硬压板遥信 1 Spare Plate 1 Spare HardPre.Plate1	3001	备用硬压板遥信 2 Spare Plate 2 Spare HardPre.Plate2	3002
备用硬压板遥信 3 Spare Plate 3 Spare HardPre.Plate3	3003	备用硬压板遥信 4 Spare Plate 4 Spare HardPre.Plate4	3004
备用硬压板遥信 5 Spare Plate 5 Spare HardPre.Plate5	3005	备用硬压板遥信 6 Spare Plate 6 Spare HardPre.Plate6	3006
备用硬压板遥信 7 Spare Plate 7 Spare HardPre.Plate7	3007	备用硬压板遥信 8 Spare Plate 8 Spare HardPre.Plate8	3008
备用硬压板遥信 9 Spare Plate 9 Spare HardPre.Plate9	3009	备用硬压板遥信 10 Spare Plate 10 Spare HardPre.Plate10	3010
备用硬压板遥信 11 Spare Plate 11	3011	备用硬压板遥信 12 Spare Plate 12	3012

Spare HardPre.Plate11		Spare HardPre.Plate12	
备用硬压板遥信 13 Spare Plate 13 Spare HardPre.Plate13	3013	备用硬压板遥信 14 Spare Plate 14 Spare HardPre.Plate14	3014
备用硬压板遥信 Spare Plate 15 15Spare HardPre.Plate15	3015	备用硬压板遥信 16 Spare Plate 16 Spare HardPre.Plate16	3016
备用硬压板遥信 17 Spare Plate 17 Spare HardPre.Plate17	3017	备用硬压板遥信 18 Spare Plate 18 Spare HardPre.Plate18	3018
备用硬压板遥信 19 Spare Plate 19 Spare HardPre.Plate19	3019	备用硬压板遥信 20 Spare Plate 20 Spare HardPre.Plate20	3020
1QF 故障闭锁 1QF Fault Block	3021	2QF 故障闭锁 2QF Fault Block	3022
I 段 PT 投入 I PT Input	3023	II 段 PT 投入 II PT Input	3024
PT 并列硬压板 PT Parallel Plate PT Par.HardPre.Plate	3025	备投允许 Standby Power Automatic Switch Permission SPA.Permission	3026
备自投投入 Enable Standby Power Automatic Switch E.SPAS	3027	备自投自动复归 Enable Standby Power Automatic Switch and Reset E.SPASaR	3028
闭锁保护 Block Protection	3029	闭锁备自投 Block Standby Power Automatic Switch Bl.SPAS	3030
闭锁电压输入 Block Voltage Input	3031	闭锁重合闸 BlockReclosing	3032
差动保护硬压板 Differential Protection Plate Differ.HardPre.Plate	3033	投低压侧跳闸 Enable Low Voltage Trip LV.T Input	3034
投高压侧跳闸 Enable High Voltage Trip HV.T Input	3035	投过流保护 Enable Overcurrent Protection Overcurrent.P Input	3036
允许遥控并列 Remote Parallel Permission Remote Par.Allowed	3037	允许自动并列 Automatic Parallel Permission Automatic Par.Allowed	3038
置检修状态 Maintenance	3039	重合闸压板 Reclosing Plate	3040

		Reclosing Pre.Plate	
自投开关投入 Enable Automatic Switch AutomaticSwitch Input	3041		
信号量遥信 Signal			
备用信号量遥信 1 Spare Signal 1 Spare Signal1	4001	备用信号量遥信 2 Spare Signal 2 Spare Signal2	4002
备用信号量遥信 3 Spare Signal 3 Spare Signal3	4003	备用信号量遥信 4 Spare Signal 4 Spare Signal4	4004
备用信号量遥信 5 Spare Signal 5 Spare Signal5	4005	备用信号量遥信 6 Spare Signal 6 Spare Signal6	4006
备用信号量遥信 7 Spare Signal 7 Spare Signal7	4007	备用信号量遥信 8 Spare Signal 8 Spare Signal8	4008
备用信号量遥信 9 Spare Signal 9 Spare Signal9	4009	备用信号量遥信 10 Spare Signal 10 Spare Signal10	4010
备用信号量遥信 11 Spare Signal 11 Spare Signal11	4011	备用信号量遥信 12 Spare Signal 12 Spare Signal12	4012
备用信号量遥信 13 Spare Signal 13 Spare Signal13	4013	备用信号量遥信 14 Spare Signal 14 Spare Signal14	4014
备用信号量遥信 15 Spare Signal 15 Spare Signal15	4015	备用信号量遥信 16 Spare Signal 16 Spare Signal16	4016
备用信号量遥信 17 Spare Signal 17 Spare Signal17	4017	备用信号量遥信 18 Spare Signal 18 Spare Signal18	4018
备用信号量遥信 19 Spare Signal 19 Spare Signal19	4019	备用信号量遥信 20 Spare Signal 20 Spare Signal20	4020
一段系统接地 System Ground Pri.System Ground	4021	PT 断线 PT Break	4022
失压脱扣 Loss Voltage Trip LV.T	4023	复位信号 ResetSignal	4024

运行状态 Running State	4025	负控保护 Load Control Protection Nega.Control.P	4026
电压并列 Voltage Parallel	4027	系统谐振信号 System Resonance Signal Sys.Resonance Sig.	4028
系统接地信号 System Ground Signal Sys.Ground Sig.	4029	绝缘监察 Insulation Monitor	4030
主变异常信号 Transformer Abnormal Signal Transf.Abnormal Sig.	4031	CT 二次过压 CT Secondary Over Voltage CT Secondary.OV	4032
事故跳闸输入 Emergency Trip Input Emergency.T input	4033	电源监视 Power Monitor	4034
发电机启动 Generator Start Alternator Start	4035	发电机故障 Generator Failure Alternator Failure	4036
控制回路断线 Control Circuit Break CtrError Act	4037	PT 电压切换 PT Voltage Switch Pt Voltage Switch	4038
电压不平衡信号 Unbalance Votage Signal Unbalance.V Sig.	4039	本段 PT 失压 PT Loss Voltage Pri.Sec.PT V.LOSS	4040
风扇已运行 Running Blower	4041	PT 并列 PT Parallel	4042
控制回路正常 Control Circuit Normal CtrError Normal	4043	电容器故障信号 Capacitor Failure Signal Capac.Failure Sig.	4044

## Appendix C Relay Event

AM 事件记录 AM Event Record				
事件代码 Event code	事件名称 Event name	参数名称 Parameter name	参数值 Parameter values	参数单位 Parameter unit
0	过流一段保护 [Instantaneous overcurrent] 3I>>>	A 相电流 Ia	浮点数 Float	A
		B 相电流 Ib	浮点数 Float	A
		C 相电流 Ic	浮点数 Float	A
		UAB	浮点数 Float	V
		UBC	浮点数 Float	V
		UCA	浮点数 Float	V
		负序电压 Negative sequence voltage U2	浮点数 Float	V
		A 相二次谐波电流 Ia Second Harmonic Ia_H2	浮点数 Float	A
		B 相二次谐波电流 Ib Second Harmonic Ib_H2	浮点数 Float	A
		C 相二次谐波电流 Ic Second Harmonic Ic_H2	浮点数 Float	A
1	过流二段保护 [Time-limited overcurrent] 3I>>	A 相电流 Ia	浮点数 Float	A
		B 相电流 Ib	浮点数 Float	A
		C 相电流 Ic	浮点数 Float	A
		UAB	浮点数 Float	V
		UBC	浮点数	V

			Float	
		UCA	浮点数 Float	V
		负序电压 Negative sequence voltage U2	浮点数 Float	V
		A 相二次谐波电流 Ia Second Harmonic Ia_H2	浮点数 Float	A
		B 相二次谐波电流 Ib Second Harmonic Ib_H2	浮点数 Float	A
		C 相二次谐波电流 Ic Second Harmonic Ic_H2	浮点数 Float	A
2	过流三段保护 [Definite time overcurrent] 3I>	A 相电流 Ia	浮点数 Float	A
		B 相电流 Ib	浮点数 Float	A
		C 相电流 Ic	浮点数 Float	A
		UAB	浮点数 Float	V
		UBC	浮点数 Float	V
		UCA	浮点数 Float	V
		负序电压 Negative sequence voltage U2	浮点数 Float	V
		A 相二次谐波电流 Ia Second Harmonic Ia_H2	浮点数 Float	A
		B 相二次谐波电流 Ib Second Harmonic Ib_H2	浮点数 Float	A
		C 相二次谐波电流 Ic Second Harmonic Ic_H2	浮点数 Float	A



3	启动时过流一段保护 [Motor Start Instantaneous overcurrent] 3I>>>.S	A相电流 Ia	浮点数 Float	A
		B相电流 Ib	浮点数 Float	A
		C相电流 Ic	浮点数 Float	A
4	运行时过流一段保护 [Motor Run Instantaneous overcurrent] 3I>>>.R	A相电流 Ia	浮点数 Float	A
		B相电流 Ib	浮点数 Float	A
		C相电流 Ic	浮点数 Float	A
5	A相反时限过流保护 [Ia Inverse Definite Minimum Time overcurrent] Ia>InverseT.	时间 t	浮点数	s
		A相电流 Ia	浮点数 Float	A
		B相电流 Ib	浮点数 Float	A
		C相电流 Ic	浮点数 Float	A
		UAB	浮点数 Float	V
		UBC	浮点数 Float	V
		UCA	浮点数 Float	V
		负序电压 Negative sequence voltage U2	浮点数 Float	V
6	B相反时限过流保护 [Ib Inverse Definite Minimum Time overcurrent] Ib>InverseT.	时间 t	浮点数	s
		A相电流 Ia	浮点数 Float	A
		B相电流 Ib	浮点数 Float	A
		C相电流 Ic	浮点数 Float	A
		UAB	浮点数 Float	V
		UBC	浮点数 Float	V

		UCA	浮点数 Float	V
		负序电压 Negative sequence voltage U2	浮点数 Float	V
7	C 相反时限过流保护 [Ic Inverse Definite Minimum Time overcurrent] Ic>InverseT.	时间 t	浮点数	s
		A 相电流 Ia	浮点数 Float	A
		B 相电流 Ib	浮点数 Float	A
		C 相电流 Ic	浮点数 Float	A
		UAB	浮点数 Float	V
		UBC	浮点数 Float	V
		UCA	浮点数 Float	V
		负序电压 Negative sequence voltage U2	浮点数 Float	V
8	I01 过流一段 [I01 ground fault Instantaneous overcurrent] I01>>>>	I01	浮点数 Float	A
9	I01 过流二段 [I01 ground fault Time-limited overcurrent] I01>>	I01	浮点数 Float	A
10	I02 过流一段 [I02 ground fault Instantaneous overcurrent] I02>>>>	I02	浮点数 Float	A
11	I02 过流二段 [I02 ground fault Time-limited overcurrent] I02>>	I02	浮点数 Float	A
12	I01 反时限 [I01 ground fault Inverse	时间 t	浮点数 Float	s

	Definite Minimum Time overcurrent] I01>InverseT.	I01	浮点数 Float	A
13	I02 反时限 [I02 ground fault Inverse Definite Minimum Time overcurrent] I02>InverseT.	时间 t	浮点数 Float	s
		I02	浮点数 Float	A
14	后加速过流保护 [Post-accelerated overcurrent] I>P.T	A 相电流 Ia	浮点数 Float	A
		B 相电流 Ib	浮点数 Float	A
		C 相电流 Ic	浮点数 Float	A
15	重合闸 [Auto-recloser] Reclose	——	——	——
16	低频减载 [Under Frequency] UnderFr.	频率 Frequency	浮点数 Float	Hz
17	手动合闸 [ManualClose]	——	——	——
18	手动分闸 [ManualTrip]	——	——	——
19	过负荷跳闸 I>Lo.T [OverLoadTrip]	最大相电流 Maximum current Im	浮点数 Float	A
20	负序过流一段保护 [Negative sequence Instantaneous overcurrent] I2>>>>	负序电流 Negative sequence current I2	浮点数 Float	A
		最大相电流 Maximum current Im	浮点数 Float	A
21	负序反时限保护 [Negative sequence Inverse Definite Minimum Time] overcurrent I2>InverseT	时间 t	浮点数 Float	s
		负序电流 Negative sequence current I2	浮点数 Float	A

22	热过载跳闸 [Thermal overload Trip] OverHeat.T	跳闸百分比 Trip Percent	浮点数 Float	%
		最大相电流 Maximum current Im	浮点数 Float	A
		正序电流 Positive sequence current I1	浮点数 Float	A
		负序电流 Negative sequence current I2	浮点数 Float	A
23	堵转保护 [Blocking Rotor StallTrip]	最大相电流 Maximum current Im	浮点数 Float	A
24	启动时间过长保护 [Starting time-out] StartOutTime	最大相电流 Maximum current Im	浮点数 Float	A
25	低电压保护 [Under Voltage Trip] LVP.T	最大线电压 Maximum voltage Um	浮点数 Float	V
26	欠电压保护 [Under Voltage Trip] LVP.T	UAB	浮点数 Float	V
		UBC	浮点数 Float	V
		UCA	浮点数 Float	V
27	过电压保护 [Over Voltage Trip] OVP.T	UAB	浮点数 Float	V
		UBC	浮点数 Float	V
		UCA	浮点数 Float	V
28	零序过电压保护/自产零序过 压保护 [Residual Over Voltage Trip/Self-produced Residual Over Voltage Trip] U0.OVP/3U0.OVP	零序电压 Residual voltage U0	浮点数 Float	V
29	不平衡电压保护 [Unbalance Voltage Trip]	不平衡 U Unbalance Voltage	浮点数 Float	V

	Unb.V.T	Unb.V		
30	不平衡电流保护 [Unbalance Current Trip] Unb.I.T	不平衡 I Unbalance Current Unb.I	浮点数 Float	A
31	重瓦斯跳闸 [Severe Gas Trip] SevereGas.T	——	——	——
32	压力释放跳闸 [Pressure Release Trip] Pre.Re.T	——	——	——
33	超温跳闸 [High Temperature Trip] HighTemp.T	——	——	——
34	非电量 1 跳闸/计量门 1 跳闸 [Non-electricity 1 Trip/Meter-door 1 Trip] Non-el1.T/Me.do1.T	——	——	——
35	非电量 2 跳闸/计量门 2 跳闸 [Non-electricity 2 Trip/Meter-door 2 Trip] Non-el2.T/Me.do2.T	——	——	——
36	分段备投合母联 [Bus Standby Power Automatic Switch Close Bus] B.S.C.B.	——	——	——
37	分段备投跳进线 1 [Bus Standby Power Automatic Switch Trip 1 Incoming] B.S.T.1	——	——	——
38	分段备投跳进线 2 [Bus Standby Power Automatic Switch Trip 2 Incoming] B.S.T.2	——	——	——
39	2 备 1 跳进线 1 [2 Incoming Spare power, 1 Incoming Primary power, trip 1 Incoming] 2S.1T.1-In.	——	——	——
40	2 备 1 合进线 2 [2 Incoming Spare power, 1	——	——	——

	Incoming Primary power, close 2 Incoming] 2S.1C.2-In.			
41	1 备 2 跳进线 2 [1 Incoming Spare power, 2 Incoming Primary power, trip 2 Incoming] 1S.2T.2-In.	—	—	—
42	1 备 2 合进线 1 [1 Incoming Spare power, 2 Incoming Primary power, close 1 Incoming] 1S.2C.1-In.	—	—	—
43	分段复归合进线 1 [Bus Standby Power Automatic Reset Close 1 Incoming] B.R.C.1	—	—	—
44	分段复归合进线 2 [Bus Standby Power Automatic Reset Close 2 Incoming] B.R.C.2	—	—	—
45	分段复归跳母联 [Bus Standby Power Automatic Reset Trip Bus] B.R.T.B.	—	—	—
46	2 备 1 复归合进线 1 [2 Incoming Spare power, 1 Incoming Primary power, Reset close 1 Incoming] 2S.1R.C.1	—	—	—
47	2 备 1 复归跳进线 2 [2 Incoming Spare power, 1 Incoming Primary power, Reset trip 2 Incoming] 2S.1R.T.2	—	—	—
48	1 备 2 复归合进线 2 [1 Incoming Spare power, 2 Incoming Primary power, Reset close 2 Incoming] 1S.2R.C.2	—	—	—
49	1 备 2 复归跳进线 1	—	—	—

	[1 Incoming Spare power, 2 Incoming Primary power, Reset trip 1 Incoming] 1S.2R.T.1			
50	FC 闭锁 [FC Block]	A 相电流 Ia	浮点数 Float	A
		B 相电流 Ib	浮点数 Float	A
		C 相电流 Ic	浮点数 Float	A
51	变压器门误开跳闸 [Transformer Door Open Trip] DoorOpenT	——	——	——
52	遥控合闸 [RemoteClose]	——	——	——
53	遥控分闸 [RemoteTrip]	——	——	——
54	失压保护 [Loss of Voltage Trip] LVP.T	最大线电压 Maximum voltage Um	浮点数 Float	V
55	油位低跳闸 [Low oil Trip] Low oil.T	——	——	——
56	油位高跳闸 [High oil Trip] High oil.T	——	——	——
57	反时限过流保护 [Inverse Definite Time overcurrent] I>InverseT.	时间 t	浮点数 Float	s
		A 相电流 Ia	浮点数 Float	A
		B 相电流 Ib	浮点数 Float	A
		C 相电流 Ic	浮点数 Float	A
58	I01 过流三段 [I01 ground fault Definite time overcurrent] I01>	I01	浮点数 Float	A
59	I01 后加速过流 [I01 ground fault Post-accelerated overcurrent] I01>P.T	时间 t	浮点数 Float	s
		I01	浮点数 Float	A

60	高温保护跳闸 [Over Temperature Trip] OverTemp.T	—	—	—
61	轻瓦斯保护跳闸 [Light Gas Trip] LightGasT	—	—	—
62	2 备 1 跳母联 [2 Incoming Spare power, 1 Incoming Primary power, trip bus] 2S.1T.B.	—	—	—
63	2 备 1 复归合母联 [2 Incoming Spare power, 1 Incoming Primary power, Reset close bus] 2S.1R.C.B.	—	—	—
64	柴发机备投跳进线 1 [Diesel Generator Standby Power Automatic Switch Trip 1 Incoming] Die.S.T.1	—	—	—
65	柴发机备投跳进线 2 [Diesel Generator Standby Power Automatic Switch Trip 2 Incoming] Die.S.T.2	—	—	—
66	柴发机备投合母联 [Diesel Generator Standby Power Automatic Switch Close Bus] Die.S.C.B.	—	—	—
67	柴发机备投合柴发机 [Diesel Generator Standby Power Automatic Switch Close Diesel Gnerator] Die.S.C.D.	—	—	—
68	非电量 3 跳闸 [Non-electricity 3 Trip] Non-el3.T	—	—	—
69	非电量 4 跳闸 [Non-electricity 4 Trip]	—	—	—



	Non-cl4.T			
70	备用 1 跳闸 [Spare 1 Trip] Spare1.T	—	—	—
71	备用 2 跳闸 [Spare 2 Trip] Spare2.T	—	—	—
73	备用 3 跳闸 [Spare 3 Trip] Spare3.T	—	—	—
74	隔离柜连跳 [Isolation Intertrip] Iso.Cab.T	—	—	—
75	系统谐振跳闸 [System Resonanc Trip] Sys.Res.T	—	—	—
76	高频保护 [Over Frequency] OF.T	频率 Frequency	浮点数 Float	Hz
77	温控器故障跳闸 [Temperature Controller Failure Trip] Th.Fa.T	—	—	—
78	自产 3I0 保护一段跳闸 [Self-produce ground fault Instantaneous overcurrent] 3I0>>>	A 相电流 Ia	浮点数 Float	A
		B 相电流 Ib	浮点数 Float	A
		C 相电流 Ic	浮点数 Float	A
		3I0	浮点数 Float	A
79	自产 3I0 保护二段跳闸 [Self-produce ground fault Time-limited overcurrent] 3I0>>	A 相电流 Ia	浮点数 Float	A
		B 相电流 Ib	浮点数 Float	A
		C 相电流 Ic	浮点数 Float	A
		3I0	浮点数 Float	A
80	过负荷告警 I>Lo.A	最大相电流 Maximum current	浮点数 Float	A

	[Over Load Alarm] OverLoadAla.	Im		
81	PT 断线告警 (AM5、AM4-U) [PT Break Alarm] PT BreakAla.	UAB	浮点数 Float	V
		UBC	浮点数 Float	V
		UCA	浮点数 Float	V
		负序电压 Negative sequence voltage U2	浮点数 Float	V
82	控故障告警 [Control Circuit Break Alarm] CtrErrorAla.	—	—	—
83	负序过流二段告警 [Negative sequence Time-limited overcurrent Alarm] I2>>.A	负序电流 I2	浮点数 Float	A
		最大相电流 Maximum current Im	浮点数 Float	A
84	热过载告警 [Thermal overload Alarm] OverHeat.A	告警百分比 Alarm percent	浮点数 Float	%
		最大相电流 Maximum current Im	浮点数 Float	A
		正序电流 Positive sequence current I1	浮点数 Float	A
		负序电流 Negative sequence current I2	浮点数 Float	A
85	I母低电压告警 LVP.A (AM5\AM4-U1) [I Bus Under Voltage Alarm] I Bus LVP.A	最大线电压 Maximum voltage Um	浮点数 Float	V
86	I母过电压告警 (AM5\AM4-U1)	最大线电压 Maximum voltage	浮点数 Float	V

	[I Bus Over Voltage Alarm] I Bus OVP.A	Um		
87	I母零序过压告警 (AM5\AM4-U1) [I Bus Residual Over Voltage] Alarm I Bus U0.OVP.A	零序电压 Residual Voltage U0	浮点数 Float	V
88	轻瓦斯告警 [Light Gas Alarm] LightGasA			
89	高温告警 [Over Temperature Alarm] OverTemp.A			
90	非电量 2 告警 [Non-electricity 2 Alarm] Non-el2.A	——	——	——
91	非电量 3 告警 [Non-electricity 3 Alarm] Non-el3.A	——	——	——
92	分段充电完成 [BusCharge]	——	——	——
93	进线 1 充电完成 [1 In-coming Charge] I-In.Charge	——	——	——
94	进线 2 充电完成 [2 In-coming Charge] 2-In.Charge	——	——	——
95	I母自产零序过压告警 (AM5\AM4-U1) [I Bus Self-produced Residual Over Voltage Alarm] I Bus 3U0.OVP.A	零序电压 Residual Voltage U0	浮点数 Float	V
96	II母低电压告警 (AM5\AM4-U2) [II Bus Under Voltage Alarm] II Bus LVP.A	最大线电压 Maximum voltage Um	浮点数 Float	V
97	II母零序过压告警 (AM5\AM4-U2) [II Bus Residual Over Voltage Alarm] II Bus U0.OVP.A	零序电压 Residual Voltage U0	浮点数 Float	V
98	II母 PT 断线告警	UAB2	浮点数	V

	(AM5\AM4-U2) [II Bus PT Break Alarm] II Bus PT BreakAla.		Float	
		UBC2	浮点数 Float	V
		UCA2	浮点数 Float	V
		负序电压 Negative sequence voltage U2	浮点数 Float	V
99	II母过电压告警 (AM5\AM4-U2) [II Bus Over Voltage Alarm] II Bus OVP.A	最大线电压 Maximum voltage Um	浮点数 Float	V
100	II母自产零序过压告警 (AM5\AM4-U2) [II Bus Self-produced Residual Over Voltage Alarm] II Bus 3U0.OVP.A	零序电压 Residual Voltage U0	浮点数 Float	V
101	电机备投跳进线 1,2 [Motor Standby Power Automatic Switch Trip 1,2 Incoming] M.S.T.1,2	——	——	——
102	电机备投合电机 [Motor Standby Power Automatic Switch Close Motor] M.S.C.M.	——	——	——
103	过流三段告警 [Definite time overcurrent Alarm] 3I>.A	A 相电流 Ia	浮点数 Float	A
		B 相电流 Ib	浮点数 Float	A
		C 相电流 Ic	浮点数 Float	A
104	I01 过流一段告警 [I01 ground fault Instantaneous overcurrent Alarm] I01>>>.A	时间 t	浮点数 Float	s
		I01	浮点数 Float	A
105	I01 过流二段告警 [I01 ground fault Time-limited overcurrent Alarm]	时间 t	浮点数 Float	s
		I01	浮点数	A

	I01>>.A		Float	
106	I01 过流三段告警 [I01 ground fault Definite time overcurrent Alarm] I01>.A	时间 t	浮点数 Float	s
		I01	浮点数 Float	A
107	I01 反时限过流告警 [I01 ground fault Inverse Definite Minimum Time overcurrent Alarm] I01>InverseT.A	时间 t	浮点数 Float	s
		I01	浮点数 Float	A
108	I01 后加速告警 [I01 ground fault Post-accelerated overcurrent Alarm] I01>P.A	时间 t	浮点数 Float	s
		I01	浮点数 Float	A
109	I02 过流告警 [I02 ground fault overcurrent Alarm] I02>.A	时间 t	浮点数 Float	s
		I02	浮点数 Float	A
110	I02 反时限过流告警 [I02 ground fault Inverse Definite Time overcurrent Alarm] I02>InverseT.A	时间 t	浮点数 Float	s
		I02	浮点数 Float	A
111	负序过流一段告警 [Negative sequence Instantaneous overcurrent Alarm] I2>>>.A	负序电流 Negative sequenc current I2	浮点数 Float	A
		最大相电流 Maximum current Im	浮点数 Float	A
112	超温保护告警 [High Temperature Alarm] HighTemp.A			
113	重瓦斯保护告警 [Severe Gas Alarm] SevereGas.A			

114	失压告警 [Loss of Voltage Alarm] LVP.A	最大线电压 Maximum voltage Um	浮点数 Float	V
115	I02 过流一段告警 [I02 ground fault Instantaneous overcurrent Alarm] I02>>>.A	时间 t	浮点数 Float	s
		I02	浮点数 Float	A
116	I02 过流二段告警 段告警 [I02 ground fault Time-limited overcurrent Alarm] I02>>.A	时间 t	浮点数 Float	s
		I02	浮点数 Float	A
117	门开告警 [Transformer Door Alarm] DoorOpenA	时间 t	浮点数 Float	s
118	进线 PT 断线 [In-coming PT Break Alarm] I.PtBr.A	——	——	——
119	非电量 1 告警 [Non-electricity 1 Alarm] Non-el1.A			s
120	非电量 4 告警 [Non-electricity 4 Alarm] Non-el4.A			s
121	重合闸充电完成 [Auto-reclose Charge] chargeOK	——	——	——
122	备用 1 告警 [Spare 1 Alarm] Spare1.A	——	——	——
123	备用 2 告警 [Spare 2 Alarm] Spare2.A	——	——	——
124	备用 3 告警 [Spare 3 Alarm] Spare3.A	——	——	——
125	市电充电 [Power Supply Charge] Mark.Charge	——	——	——
126	市电备投跳发电机	——	——	——

	[Power Supply Standby Power Automatic Switch Trip Generator] Mark.S.T.D.			
127	市电备投合进线 1 [Power Supply Standby Power Automatic Switch Close 1 In-coming] Mark.S.C.1	—	—	—
128	市电备投合进线 2 [Power Supply Standby Power Automatic Switch Close 2 In-coming] Mark.S.C.2	—	—	—
129	逆功率保护 [Reverse Power Trip] R.P.T	有功功率 Active power	浮点数 Float	kW
		功率因数 Power factor	浮点数 Float	
130	压力释放告警 [Pressure Release Alarm] Pre.Re.A	—	—	—
131	发电机备 1 充电 [Generator Spare power, 1 In-coming Primary power Charge] A1.S.1.Charge	—	—	—
132	发电机备 2 充电 [Generator Spare power, 2 In-coming Primary power Charge] A1.S.2.Charge	—	—	—
133	柴发机备 1 跳 1QF [Diesel Generator Spare power, 1 In-coming Primary, Trip 1QF] Die.S.1T.1QF	—	—	—
134	柴发机备 1 合 4QF [Diesel Generator Spare power, 1 In-coming Primary, Close 4QF] Die.S.1C.4QF	—	—	—
135	柴发机备 2 跳 2QF	—	—	—

	[Diesel Generator Spare power, 2 In-coming Primary, Trip 2QF] Die.S.2T.2QF			
136	柴发机备 2 合 4QF [Diesel Generator Spare power, 2 In-coming Primary, Close 4QF] Die.S.2C.4QF	—	—	—
137	温控器故障告警 [Temperature Controller Failure Alarm] Th.Fa.A	—	—	—
138	二次过压告警（非电量） [Secondary Over Voltage Alarm] Se.OVP.A	—	—	—
139	不平衡电流 3I0 保护告警 [Unbalance Current Alarm] Unb.3I0.A	A 相电流 Ia	浮点数 Float	A
		B 相电流 Ib	浮点数 Float	A
		C 相电流 Ic	浮点数 Float	A
		3I0	浮点数 Float	A
150	DI1 变位 [DI1 Set] DI1	—	—	—
151	DI2 变位 [DI2 Set] DI2	—	—	—
152	DI3 变位 [DI3 Set] DI3	—	—	—
153	DI4 变位 [DI4 Set] DI4	—	—	—
154	DI5 变位 [DI5 Set] DI5	—	—	—
155	DI6 变位	—	—	—



	[DI6 Set] DI6			
156	DI7 变位 [DI7 Set] DI7	—	—	—
157	DI8 变位 [DI8 Set] DI8	—	—	—
158	DI9 变位 [DI9 Set] DI9	—	—	—
159	DI10 变位 [DI10 Set] DI10	—	—	—
160	DI11 变位 [DI11 Set] DI11	—	—	—
161	DI12 变位 [DI12 Set] DI12	—	—	—
162	DI13 变位 [DI13 Set] DI13	—	—	—
163	DI14 变位 [DI14 Set] DI14	—	—	—
164	DI15 变位 [DI15 Set] DI15	—	—	—
165	DI16 变位 [DI16 Set] DI16	—	—	—
166	DI17 变位 [DI17 Set] DI17	—	—	—
167	DI18 变位 [DI18 Set] DI18	—	—	—
168	DI19 变位 [DI19 Set] DI19	—	—	—
169	DI20 变位	—	—	—

	[DI20 Set] DI20			
170	合后位置变位 [Position after closing set]	——	——	——
171	合位监视变位 [Circuit Breaker On Set] CCB On set	——	——	——
172	分位监视变位 [Circuit Breaker Off Set] CCB Off set	——	——	——
173	防跳监视变位 [Anti-pumping set]	——	——	——
174	装置上电 [Device on power]	——	——	——
179	PT 断线 [PT Break]	——	——	——
180	3 备 1 充电 [3 In-coming Spare power, 1 In-coming Primary power Charge] 3S.1 Charge	——	——	——
181	3 备 2 充电 [3 In-coming Spare power, 2 In-coming Primary power Charge] 3S.2 Charge	——	——	——
182	A 相差压跳闸 [Phase A Differential Voltage Trip] UdA.T	A 相差压 Phase A Differential Voltage UdA	浮点数 Float	V
183	B 相差压跳闸 [Phase B Differential Voltage] UdB.T	B 相差压 Phase B Differential Voltage UdB	浮点数 Float	V
184	C 相差压跳闸 [Phase C Differential Voltage] UdC.T	C 相差压 Phase C Differential Voltage UdC	浮点数 Float	V
185	备投再恢复 1#合 3QF [Standby Power Automatic Switch Reset 1#, Close 3QF]	——	——	——

	S.R.1#.C.3QF			
186	均无压恢复充电 [Loss of Voltage Reset Charge] No-Vol.R.Charge	—	—	—
187	均无压复 2 跳 4 [Loss of Voltage Reset 2 In-coming Trip 4 In-coming] No-Vol.R.2.T.4	—	—	—
188	均无压复 2 合 2 [Loss of Voltage Reset 2 In-coming Close 4 In-coming] No-Vol.R.2.C.2	—	—	—
189	均无压复 1 跳 4 [Loss of Voltage Reset 1 In-coming Trip 4 In-coming] No-Vol.R.1.T.4	—	—	—
190	均无压复 1 合 1 [Loss of Voltage Reset 1 In-coming Close 1 In-coming] No-Vol.R.1.C.1	—	—	—
191	均无压复 1 合 3 [Loss of Voltage Reset 1 In-coming Close 3 In-coming] No-Vol.R.1.C.3	—	—	—
192	远方按钮合闸 [Remote button close]	—	—	—
193	远方按钮分闸 [Remote button trip]	—	—	—
194	急停分闸 [Emergency trip]	—	—	—
195	2 备 1 合柴发 [2 In-coming Spare power, 1 In-coming Primary power, Close Diesel Generator] 2S.1C.Die.	—	—	—
196	2 备 1 复归跳柴发 [2 In-coming Spare power, 1 In-coming Primary power, Reset Trip Diesel Generator] 2S.1R.T.Die.	—	—	—
197	负控跳闸 [Load Control Trip]	—	—	—

	Neg.Con.T			
198	绝缘监测告警 [Residual Monitor Alarm] Insul.Monit.A	—	—	—
199	绝缘监测跳闸 [Residual Monitor Trip] Insul.Monit.T	—	—	—
200	均无压充电 [Loss of Voltage Charge] No-Vol.Charge	—	—	—
201	均无压跳 2 [Loss of Voltage Trip 2 In-coming] No-Vol.T.2	—	—	—
202	均无压合 1 [Loss of Voltage Close 1 In-coming] No-Vol.C.1	—	—	—
203	备用进线备 1 充电 [Spare In-coming Standby Power Automatic Switch 1 In-coming Charge] Sp.In.S1 Charge	—	—	—
204	备用进线备 2 充电 [Spare In-coming Standby Power Automatic Switch 2 In-coming Charge] Sp.In.S2 Charge	—	—	—
205	备用进线备 1 跳进线 1 [Spare In-coming Standby Power Automatic Switch 1 In-coming Trip 1 In-coming] Sp.In.S1.T.1	—	—	—
206	备用进线备 1 合备用 [Spare In-coming Standby Power Automatic Switch 1 In-coming Close Spare In-coming] Sp.In.S1.C.Sp.	—	—	—
207	备用进线备 2 跳进线 2 [Spare In-coming Standby Power Automatic Switch 2	—	—	—

	In-coming Trip 2 In-coming] Sp.In.S2.T.2			
208	备用进线备 2 合备用 [Spare In-coming Standby Power Automatic Switch 2 In-coming Close Spare In-coming] Sp.In.S2.C.Sp	—	—	—
209	均无压跳进线 1,2 [Loss of Voltage Trip 1,2 In-coming] No-Vol.T.1,2	—	—	—
210	均无压合母联 [Loss of Voltage Close Bus] No-Vol.C.B.	—	—	—
211	均无压合备用进线 [Loss of Voltage Close Spare In-coming] No-Vol.C.Sp.In.	—	—	—
212	欠流告警 [Under Current Alarm] LIP.A	A 相电流 Ia	浮点数 Float	A
		B 相电流 Ib	浮点数 Float	A
		C 相电流 Ic	浮点数 Float	A
213	电压不平衡开入跳闸 [Unbalance Voltage Trip] Unb.V.DI.T	—	—	—
214	分段备投合进线 3 [Bus Standby Power Automatic Switch Close 3 In-coming] B.S.C.3	—	—	—
215	分段备投合进线 4 [Bus Standby Power Automatic Switch Close 4 In-coming] B.S.C.4	—	—	—
216	进线 1 逆功率 [1 In-coming Reverse Power Trip] 1-In.RP.T	—	—	—

217	2 备 1 跳进线 1 手车 [2 In-coming Spare power, 1 In-coming Primary power, trip 1 In-coming Handcart] 2S.1T.1-In.Hand.	—	—	—
218	2 备 1 复归合进线 1 手车 [2 In-coming Spare power, 1 In-coming Primary power, Reset Close 1 In-coming Handcart] 2S.1R.C.1-In.Hand.	—	—	—
219	低侧网门告警 [Low side net-door Alarm] Low S.D.A	—	—	—
220	低侧网门跳闸 [Low side net-door Trip] Low S.D.T	—	—	—
221	事故总信号 [Accident Signal]	—	—	—
222	电压不平衡跳闸 [Unbalance Voltage Trip] Unb.V.T	—	—	—
223	相序保护跳闸 [Incorrect Phase Sequence Voltage Trip] Ph.Se.T	—	—	—
224	断相保护跳闸 [Voltage Phase Loss Trip] Break ph.T	—	—	—
225	I段 PT 投入 [I Bus PT Input] I PT Invest.	—	—	—
226	II段 PT 投入 [II Bus PT Input] II PT Invest.	—	—	—
227	PT 并列 [PT Parallel] PT Juxtaposition	—	—	—
228	1 号 2 号主供断电警报 [1,2 In-coming Primary power loss Alarm] 1,2 Main supply outage.A	—	—	—

229	遥控并列 [Remote Parallel] Remote Juxtaposition	——	——	——
230	遥控解列 [Remote Disconnection] Remote Splitting	——	——	——
231	母线充电保护 [Bus Charge Trip] B.Cha.T	A 相电流 Ia	浮点数 Float	A
		B 相电流 Ib	浮点数 Float	A
		C 相电流 Ic	浮点数 Float	A
232	CT 二次过压跳闸 [Secondary CT Over Voltage Trip] CT Se.OVP.T	——	——	——
233	CT 二次过压告警 [Secondary CT Over Voltage Alarm] CT Se.OVP.A	——	——	——
234	隔离手车连跳动作 [Isolation Handcart Intertrip] Iso.Handcart.T	——	——	——
235	备投允许 [Standby Power Automatic Switch Permission] Standby allowed	——	——	——
236	允许合闸信号 [Close Circuit Breaker Signal Permission] Allowable C.signal	——	——	——
237	柴发机备投跳母联 [Diesel Generator Standby Power Automatic Switch Trip Bus] Die.S.T.B.			
238	备投启动柴发信号 [Standby Power Automatic Switch Start Diesel Generator Signal] S.Sta.Die.Sig.			
239	油位高告警			

	[High oil Alarm] High oil.A			
240	均无压跳母联 [Loss of Voltage Trip Bus] No-Vol.T.B.			
241	负序过流二段跳闸 [Negative sequence Time-limited overcurrent] I2>>	负序电流 I2	浮点数 Float	A
		最大相电流 Maximum Current Im	浮点数 Float	A
242	差动总启动标志 [Differential total start flag]	——	——	——
243	差动速断保护 [Instantaneous Differential Differential quick break protection]	动作时间 Action time	浮点数 Float	s
		A 相差流 Differential IA IdA	浮点数 Float	A
		B 相差流 Differential IB IdB	浮点数 Float	A
		C 相差流 Differential IC IdC	浮点数 Float	A
		A 相制动 Restraint IA IrA	浮点数 Float	A
		B 相制动 Restraint IB IrB	浮点数 Float	A
		C 相制动 Restraint IC IrC	浮点数 Float	A
244	比率差动保护 [Differential protection with Ratio Restraining] Ratio differential protection	动作时间 Action time	浮点数 Float	s
		A 相差流 Differential IA IdA	浮点数 Float	A
		B 相差流 Differential IB IdB	浮点数 Float	A
		C 相差流 Differential IC	浮点数 Float	A



		IdC		
		A 相制动 Restraint IA IrA	浮点数 Float	A
		B 相制动 Restraint IB IrB	浮点数 Float	A
		C 相制动 Restraint IC IrC	浮点数 Float	A
245	差流越限 [Differential current overshoot]	A 相差流 Differential IA IdA	浮点数 Float	A
		B 相差流 Differential IB IdB	浮点数 Float	A
		C 相差流 Differential IC IdC	浮点数 Float	A
246	正序过流一段保护 [Positive sequence Instantaneous overcurrent] I1>>>>	定值 Fixed value	浮点数 Float	A
		延时 Delayed	浮点数 Float	s
		正序电流 Positive sequence current I1	浮点数 Float	A
247	正序过流二段保护 [Positive sequence Time-limited overcurrent] I1>>	定值 Fixed value	浮点数 Float	A
		延时 Delayed	浮点数 Float	s
		正序电流 Positive sequence current I1	浮点数 Float	A
248	正序过流反时限保护 [Positive sequence Inverse Definite Time overcurrent] I1>InverseT.	曲线类型 Curve type	整数 Integer	一般/非常/ 极端 S1/S2/S3
		启动电流 Starting current	浮点数 Float	A
		时间系数 Time coefficient	浮点数 Float	s

		动作时间 Action time	浮点数 Float	s
		正序电流 Positive sequence current I1	浮点数 Float	A
249	长启动保护告警 [Starting time-out Alarm Long start protection alarm]	计时门槛 Timing threshold	浮点数 Float	A
		动作时间 Action time	浮点数 Float	s
250	电流不平衡告警 [Unbalance current Alarm] Unb.I.A	定值 Fixed value	浮点数 Float	A
		延时 Delayed	浮点数 Float	s
		动作值 Action value	浮点数 Float	A
		平均电流 Iavg	浮点数 Float	A
251	电压不平衡告警 [Unbalance Voltage Alarm] Unb.V.A	定值 Fixed value	浮点数 Float	V
		延时 Delayed	浮点数 Float	s
		动作值 Action value	浮点数 Float	V
		平均线电压 Average Voltage Uavg	浮点数 Float	V
		UAB	浮点数 Float	V
		UBC	浮点数 Float	V
		UCA	浮点数 Float	V
252	过电压保护告警 [Over Voltage Alarm] OVP.A	定值 Fixed value	浮点数 Float	V
		延时 Delayed	浮点数 Float	s
		UAB	浮点数 Float	V
		UBC	浮点数 Float	V
		UCA	浮点数 Float	V

			Float	
		零序电压 Residual Voltage U0	浮点数 Float	V
253	零序过压保护告警 [Residual Over Voltage Alarm] U0.OVPA	定值 Fixed value	浮点数 Float	V
		延时 Delayed	浮点数 Float	s
		UAB	浮点数 Float	V
		UBC	浮点数 Float	V
		UCA	浮点数 Float	V
		零序电压 Residual Voltage U0	浮点数 Float	V
254	正序过压保护告警 [Positive Over Voltage Alarm] U1.OVPA	定值 Fixed value	浮点数 Float	V
		延时 Delayed	浮点数 Float	s
		UAB	浮点数 Float	V
		UBC	浮点数 Float	V
		UCA	浮点数 Float	V
		正序电压 Positive Voltage U1	浮点数 Float	V
255	正序过压保护跳闸 [Positive Over Voltage Trip] U1.OVP.T	定值 Fixed value	浮点数 Float	V
		延时 Delayed	浮点数 Float	s
		UAB	浮点数 Float	V
		UBC	浮点数 Float	V
		UCA	浮点数 Float	V
		正序电压 Positive Voltage	浮点数 Float	V

		U1		
256	负序过压保护告警 [Negative Over Voltage Alarm] U2.OVP.A	定值 Fixed value	浮点数 Float	V
		延时 Delayed	浮点数 Float	s
		UAB	浮点数 Float	V
		UBC	浮点数 Float	V
		UCA	浮点数 Float	V
		负序电压 Negative Voltage U2	浮点数 Float	V
257	负序过压保护跳闸 [Negative Over Voltage Trip] U2.OVP.T	定值 Fixed value	浮点数 Float	V
		延时 Delayed	浮点数 Float	s
		UAB	浮点数 Float	V
		UBC	浮点数 Float	V
		UCA	浮点数 Float	V
		负序电压 Negative Voltage U2	浮点数 Float	V
258	低电压保护告警 [Under Voltage Alarm] LVP.A	定值 Fixed value	浮点数 Float	V
		延时 Delayed	浮点数 Float	s
		UAB	浮点数 Float	V
		UBC	浮点数 Float	V
		UCA	浮点数 Float	V
		零序电压 Residual Voltage U0	浮点数 Float	V
		延时 Delayed	浮点数 Float	s

259	相序保护告警 [Incorrect Phase Sequence Voltage Alarm] Ph.Se.A	UAB	浮点数 Float	V
		UBC	浮点数 Float	V
		UCA	浮点数 Float	V
		零序电压 Residual Voltage U0	浮点数 Float	V
		正序电压 Positive Voltage U1	浮点数 Float	V
		负序电压 Negative Voltage U2	浮点数 Float	V
		平均线电压 Average Voltage Uavg	浮点数 Float	V
260	首端 CT 断线告警 [I CT Break Alarm] F.CT Break.A	——	——	——
261	尾端 CT 断线告警 [II CT Break Alarm] T.CT Break.A	——	——	——
262	I02 后加速过流 [I02 ground fault Post-acceleration overcurrent] I02>P.T	时间 t	浮点数 Float	s
		I02	浮点数 Float	A
263	I02 后加速告警 [I02 ground fault Post-acceleration overcurrent Alarm] I02>P.A	时间 t	浮点数 Float	s
		I02	浮点数 Float	A
264	差动保护长期启动 [Long term start of differential protection]	A 相差流 Differential IA IdA	浮点数 Float	A
		B 相差流 Differential IB IdB	浮点数 Float	A
		C 相差流	浮点数	A

		Differential IC IdC	Float	
265				
266				
267	I侧 CT 断线告警 [I CT Break Alarm] I CT Break.A	——	——	——
268	II侧 CT 断线告警 [II CT Break Alarm] II CT Break.A	——	——	——
269	III侧 CT 断线告警 [III CT Break Alarm] III CT Break.A	——	——	——
270	IV侧 CT 断线告警 [IV CT Break Alarm] IV CT Break.A	——	——	——
271	有压有流出口动作 [Voltage and current trip Pressure and current outlet action]	——	——	——
272	预留 (告警事件代码) Reserve			
289				
290	启动风冷 [Start air-cooled water chiller]	A 相电流 Ia	浮点数 Float	A
		B 相电流 Ib	浮点数 Float	A
		C 相电流 Ic	浮点数 Float	A
291	闭锁调压 [Blocking voltage regulation]	A 相电流 Ia	浮点数 Float	A
		B 相电流 Ib	浮点数 Float	A
		C 相电流 Ic	浮点数 Float	A
292	间隙零序过流一段跳闸 [Transient ground fault]	间隙零序电流 Transient ground	浮点数 Float	A

	Instantaneous overcurrent] Clearance I0>>>>	fault current Clearance I0		
293	间隙零序过流二段跳闸 [Transient ground fault Time-limited overcurrent] Clearance I0>>	间隙零序电流 Transient ground fault current Clearance I0	浮点数 Float	A
294	I段 PT 投入 [I Bus PT Input] I PT Invest.	——	——	——
295	II段 PT 投入 [II Bus PT Input] II PT Invest.	——	——	——
296	PT 自动并列 [PT auto-Parallel] PT Juxtaposition	——	——	——
297	遥控并列 [Remote Parallel] Remote Juxtaposition	——	——	——
298	遥控解列 [Remote Disconnection] Remote Splitting	——	——	——
299	负控保护跳闸 [Load Control Trip] Neg.Con.T	时间 t	浮点数 Float	s
300	负控保护告警 [Load Control Alarm] Neg.Con.A	时间 t	浮点数 Float	s
301	PT 自动解列 [PT Disconnection] PT Splitting	——	——	——
302	二次谐波闭锁 [Second Harmonic Block] SHB.	A 相二次谐波电流 Ia Second Harmonic Ia_H2	浮点数 Float	A
		B 相二次谐波电流 Ib Second Harmonic Ib_H2	浮点数 Float	A
		C 相二次谐波电流 Ic Second Harmonic Ic_H2	浮点数 Float	A
303	1 备 2 跳非重要负荷 [1 In-coming Spare power, 2 In-coming Primary power, trip	——	——	——

	Unimportant Load] 1S.2T.Unimp.Lo.			
304	2 备 1 跳非重要负荷 [2 In-coming Spare power, 1 In-coming Primary power, trip Unimportant Load] 2S.1T.Unimp.Lo.	—	—	—
305	I02 过流三段 [I02 ground fault Definite time overcurrent] I02>	I02	浮点数 Float	A
306	I02 过流三段告警 [I02 ground fault Definite time overcurrent Alarm] I02>.A	I02	浮点数 Float	A
307	检修状态闭锁 [Maintenance Block] Maint.Sta.B.	—	—	—
308	电机温度 1 跳闸 [Motor Temperature 1 Trip] M.Tem1.T	—	—	—
309	电机温度 1 告警 [Motor Temperature 1 Alarm] M.Tem1.A	—	—	—
310	电机温度 2 跳闸 [Motor Temperature 2 Trip] M.Tem2.T	—	—	—
311	电机温度 2 告警 [Motor Temperature 2 Alarm] M.Tem2.A	—	—	—
312	电源监视跳闸 [Power Monitor Trip] Pow.Monit.T	—	—	—
313	电源监视告警 [Power Monitor Alarm] Pow.Monit.A	—	—	—
314	备投停止柴发信号 [Standby Power Automatic Switch Stop Diesel Generator Signal] S.St.Die.Sig.			
315	启动柜故障跳闸	—	—	—



	[Starting Cabinet Failure Trip] St.Cab.Fa.T			
316	启动柜故障告警 [Starting Cabinet Failure Alarm] St.Cab.Fa.A	—	—	—
317	同期合闸 [Synchronous Close Permission] Synchronous.C	—	—	—
318	进线侧恢复充电 [In-coming Reset Charge] In.R.Charge	—	—	—
319	柴发充电 [Diesel Generator Charge] Die.Charge	—	—	—
320	市电恢复充电 [Power Supply Reset Charge] Mark.R.Charge	—	—	—
321	柴发恢复充电 [Diesel Generator Reset Charge] Die.R.Charge	—	—	—
322	柴发备投合柴发 [Diesel Generator Standby Power Automatic Switch Close Diesel Generator] Die.S.C.D.	—	—	—
323	市电恢复跳柴发 [Power Supply Standby Power Automatic Switch Reset Trip Diesel Generator] Mark.R.T.D.	—	—	—
324	市电恢复合市电 [Power Supply Standby Power Automatic Switch Reset Close Power Supply] Mark.R.C.Mark.	—	—	—
325	柴发恢复合柴发 [Diesel Generator Standby Power Automatic Switch Reset Close Diesel	—	—	—

	Generator] Mark.R.C.D.			
326	弧光保护跳闸 [Arc flash Protection Trip] Arc.Pro.T	—	—	—
327	弧光保护告警 [Arc flash Protection Alarm] Arc.Pro.A	—	—	—
328	均无压进线 1 充电 [Loss of Voltage 1 In-coming Charge] No-Vol.1-In.Charge	—	—	—
329	均无压进线 2 充电 [Loss of Voltage 2 In-coming Charge] No-Vol.2-In.Charge	—	—	—
330	均无压合 2 [Loss of Voltage Close 2 In-coming] No-Vol.C.2	—	—	—
331	均无压跳 1 [Loss of Voltage Trip 1 In-coming] No-Vol.T.1	—	—	—
332	均无压跳 3 [Loss of Voltage Trip 3 In-coming] No-Vol.T.3	—	—	—
333	A 相二次谐波 [Ia Second Harmonic Block] A.SH.	A 相二次谐波电流 Ia Second Harmonic Ia_H2	浮点数 Float	A
		B 相二次谐波电流 Ib Second Harmonic Ib_H2	浮点数 Float	A
		C 相二次谐波电流 Ic Second Harmonic Ic_H2	浮点数 Float	A
334	B 相二次谐波 [Ib Second Harmonic Block] B.SH.	A 相二次谐波电流 Ia Second Harmonic Ia_H2	浮点数 Float	A
		B 相二次谐波电流 Ib Second Harmonic	浮点数 Float	A

		Ib_H2		
		C 相二次谐波电流 Ic Second Harmonic Ic_H2	浮点数 Float	A
335	C 相二次谐波 [Ic Second Harmonic Block] C.SH.	A 相二次谐波电流 Ia Second Harmonic Ia_H2	浮点数 Float	A
		B 相二次谐波电流 Ib Second Harmonic Ib_H2	浮点数 Float	A
		C 相二次谐波电流 Ic Second Harmonic Ic_H2	浮点数 Float	A

## Appendix D AM5-FT Anti-pumping

AM5-FT anti-pumping is module that cooperate with AM series protection relay to achieve anti-pumping function of circuit breaker. Anti-pumping is divided into two types: AC/DC110V and AC/DC220V. When ordering, it is assumed to consistent with power supply (anti-pumping cannot be used under DC48V and DC24V, and it is recommended to use circuit breaker anti-pumping function). Anti-pumping adopts rail installation method, and the wiring is shown in Figure 1.

The steps for testing anti-pumping are as following:

1. Under premise of protection relay with anti-pumping, manual open and close once. If circuit breaker can be opened and closed normally, it is judged that circuit breaker is not equipped with anti-pumping;
2. After confirming circuit breaker is not equipped with anti-pumping, manual close it and then simulate once protection trip ( protection current is not removed). And simulate once manual close. If circuit breaker is closed first and then opened, it indicates that anti-pumping function is triggered;
3. After confirming circuit breaker is not equipped with anti-pumping, manual close it. Circuit breaker is closed and the manual closing signal is not removed. At this time, short the manual opening contact, and circuit breaker opens, indicating that anti-pumping function is triggered.

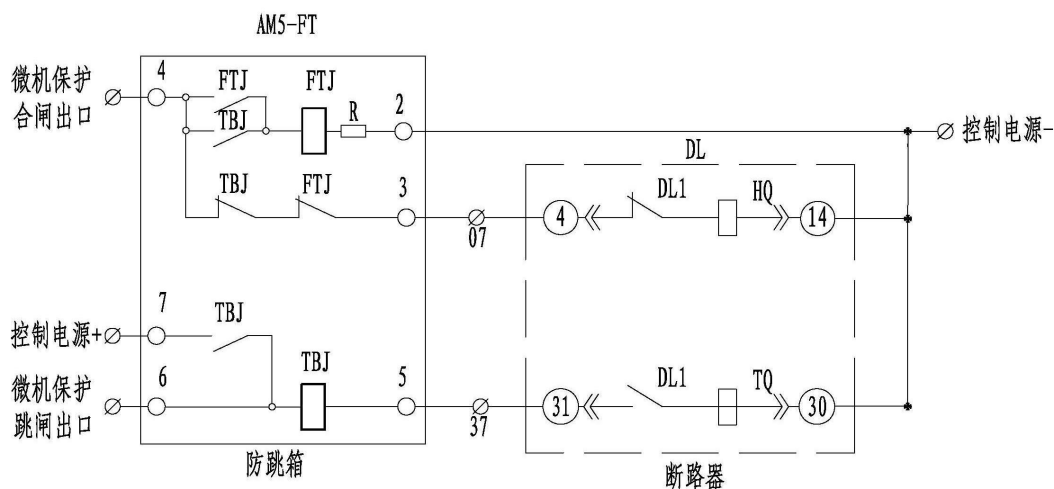

Fig. AM5-FT Anti-pumping Wiring



Fig.2 AM5-FT Front View

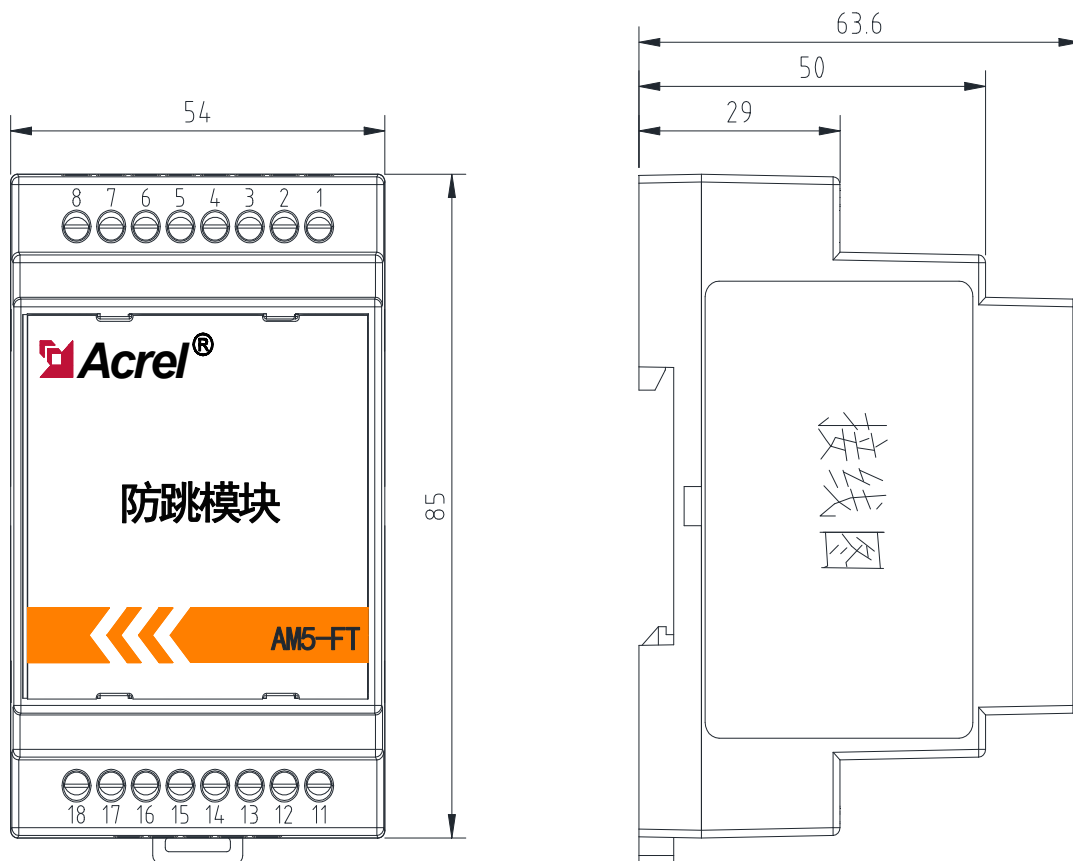

Fig.3 AM5-FT Dimensions

Headquarters: Acrel Co., Ltd.

Trade Company: Acrel E-Business(Shanghai)Co., Ltd.

Address: No.253 Yulv Road, Jiading District, Shanghai, China

TEL.: 0086-21-69156352

Web-site: [www.acrel-electric.com](http://www.acrel-electric.com)

E-mail: [sales@acrel-electric.com](mailto:sales@acrel-electric.com)

Postcode: 201801

Manufacturer: Jiangsu Acrel Electrical Manufacturing Co., Ltd.

Address: No.5 Dongmeng Road, Dongmeng industrial Park, Nanzha Street, Jiangyin City, Jiangsu  
Province, China

TEL./Fax: 0086-510-86179970

Web-site: [www.jsacrel.com](http://www.jsacrel.com)

E-mail: [sales@email.acrel.cn](mailto:sales@email.acrel.cn)

Postcode: 214405